

ARCAM | HDA

**AVR SURROUND AMPLIFIERS
AMPLIFICATEURS AVR D'AMBIANCE
AVR-SURROUND-VERSTÄRKER
AVR SURROUND AMPLIFIERS
AMPLIFICADORES SURROUND AVR
УСИЛИТЕЛИ ОБЪЕМНОГО ЗВУКА AVR
AMPLIFICATORI SURROUND AVR
AVR 环绕声放大器
AVR 서라운드 앰프**

AV41/AVR31/AVR21/AVR11

**HANDBOOK
MANUEL
HANDBUCH
HANDLEIDING
MANUAL
РУКОВОДСТВО
MANUALE
手册
핸드북**

HANDBOOK

ARCAM | HD A

AVR SURROUND AMPLIFIERS

AV41/AVR31/AVR21/AVR11

Safety Guidelines

Important Safety Instructions

1. Read these instructions.
2. Keep these instructions.
3. Heed all warnings.
4. Follow all instructions.
5. Do not use this apparatus near water.
6. Clean only with dry cloth.
7. Do not block any ventilation openings. Install in accordance with the manufacturer's instructions.
8. Do not install near any heat sources such as radiators, heat registers, stoves, or other apparatus (including amplifiers) that produce heat.
9. Do not defeat the safety purpose of the polarized or grounding-type plug.

A polarized plug has two blades with one wider than the other. A grounding type plug has two blades and a third grounding prong. The wide blade or the third prong are provided for your safety. If the provided plug does not fit into your outlet, consult an electrician for replacement of the obsolete outlet.

10. Protect the power cord from being walked on or pinched particularly at plugs, convenience receptacles, and the point where they exit from the apparatus.
11. Only use attachments/accessories specified by the manufacturer.
12. Use only with the cart, stand, tripod, bracket, or table specified by the manufacturer, or sold with the apparatus.

When a cart is used, use caution when moving the cart/apparatus combination to avoid injury from tip-over.



13. Unplug this apparatus during lightning storms or when unused for long periods of time.

14. Refer all servicing to qualified service personnel.

Servicing is required when the apparatus has been damaged in any way, such as power-supply cord or plug is damaged, liquid has been spilled or objects have fallen into the apparatus, the apparatus has been exposed to rain or moisture, does not operate normally, or has been dropped.

15. Object or liquid entry

WARNING – Take care that objects do not fall and liquids are not spilled into the enclosure through any openings. The equipment shall not be exposed to dripping or splashing. Liquid-filled objects such as vases should not be placed on the equipment.

16. Climate

The equipment has been designed for use in moderate climates and in domestic situations.

17. Cleaning

Unplug the unit from the mains supply before cleaning.

The case should normally only require a wipe with a soft, lint-free cloth. Do not use chemical solvents for cleaning.

We do not advise the use of furniture cleaning sprays or polishes as they can cause permanent white marks.

18. Power sources

Only connect the equipment to a power supply of the type described in the operating instructions or as marked on the equipment.

The primary method of isolating the equipment from the mains supply is to remove the mains plug. The equipment must be installed in a manner that makes disconnection possible.

19. Abnormal smell

If an abnormal smell or smoke is detected from the equipment, turn the power off immediately and unplug the equipment from the wall outlet. Contact your dealer and do not reconnect the equipment.

20. Damage requiring service

The equipment should be serviced by qualified service personnel when:

- A. The power-supply cord or the plug has been damaged, or

- B. Objects have fallen, or liquid has spilled into the equipment, or

- C. The equipment has been exposed to rain, or

- D. The equipment does not appear to operate normally or exhibits a marked change in performance, or

- E. The equipment has been dropped or the enclosure damaged.



CAUTION: To reduce the risk of electric shock, do not remove cover (or back). No user serviceable parts inside. Refer servicing to qualified service personnel.

WARNING: To reduce the risk of fire or electric shock, do not expose this apparatus to rain or moisture.



The lightning flash with an arrowhead symbol within an equilateral triangle, is intended to alert the user to the presence of uninsulated 'dangerous voltage' within the product's enclosure that may be of sufficient magnitude to constitute a risk of electric shock to persons.



The exclamation point within an equilateral triangle is intended to alert the user to the presence of important operating and maintenance (servicing) instructions in the literature accompanying the product.

CAUTION: In Canada and the USA, to prevent electric shock, match the wide blade of the plug to the wide slot in the socket and insert the plug fully into the socket.

Class II product

This equipment is a Class II or double insulated electrical appliance. It has been designed in such a way that it does not require a safety connection to electrical earth ("ground" in the U.S.)

Warning

Mains plug/appliance coupler is used to disconnect device and it shall remain readily operable.

Safety Compliance

This equipment has been designed to meet the IEC/EN 60065 international electrical safety standard.

This device complies with Part 15 of the FCC Rules. Operation is subject to the following two conditions:

1. This device may not cause harmful interference, and
2. This device must accept any interference received, including interference that may cause undesired operation.

The building installation shall be regarded as providing protection in accordance with the rating of the wall socket outlet.

Caution on installation

For proper heat dispersal, do not install this unit in a confined space, such as a bookcase or similar enclosure.

- More than 0.3m (12in) is recommended.
- Do not place any other equipment on this unit.

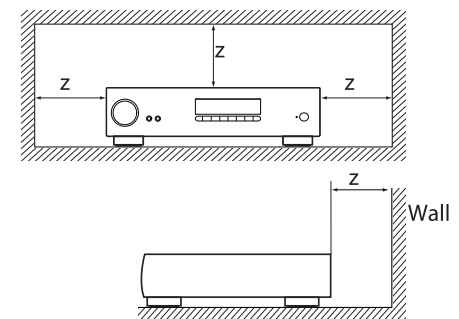

FCC Information (for US customers)**PRODUCT****CONTAINS TRANSMITTER MODULE FCC ID:****APILUXASTR01, APILUXABT01**

This product complies with Part 15 of the FCC Rules. Operation is subject to the following two conditions: (1) this product may not cause harmful interference, and (2) this product must accept any interference received, including interference that may cause undesired operation.

IMPORTANT NOTICE: DO NOT MODIFY THIS PRODUCT

This product, when installed as indicated in the instructions contained in this manual, meets FCC requirements. Modification not expressly approved by ARCAM may void your authority, granted by the FCC, to use the product.

CAUTION (For Bluetooth/Wi-Fi)

- To comply with FCC RF exposure compliance requirement, separation distance of at least 20 cm must be maintained between this product and all persons.
- This product and its antenna must not be co-located or operating in conjunction with any other antenna or transmitter.

NOTE

This product has been tested and found to comply with the limits for a Class B digital device, pursuant to Part 15 of the FCC rules. These limits are designed to provide reasonable protection against harmful interference in a residential installation.

This product generates, uses and can radiate radio frequency energy and, if not installed and used in accordance with the instructions, may cause harmful interference to radio communications. However, there is no guarantee that interference will not occur in a particular installation. If this product does cause harmful interference to radio or television reception which can be determined by turning the product OFF and ON, the user is encouraged to try to correct the interference by one or more of the following measures:

- Reorient or relocate the receiving antenna.
- Increase the separation between the equipment and the receiver.
- Connect the product into an outlet on a circuit different from that to which the receiver is connected
- Consult the local retailer authorized to distribute this type of product or an experienced radio / TV technician for help.

IC Information (For Canadian customers)**PRODUCT****CONTAINS TRANSMITTER MODULE IC:****6132A-LUXASTR01, 6132A-LUXABT01**

This product complies with RSS-247 of Industry Canada. Operation is subject to the following two conditions: (1) this product may not cause harmful interference, and (2) this product must accept any interference received, including interference that may cause undesired operation. This Class B digital apparatus complies with Canadian ICES-003.

CAUTION

To reduce potential radio interference to other users, the antenna type and its gain should be so chosen that the equivalent isotropically radiated power (e.i.r.p.) is not more than that permitted for successful communication. (i) the device for operation in the band 5,150 – 5,250 MHz is only for indoor use to reduce the potential for harmful interference to co-channel mobile satellite systems. (ii) high-power radars are allocated as primary users (i.e. priority users) of the bands 5,250 – 5,350 MHz and 5,650 – 5,850 MHz and that these radars could cause interference and/or damage to LE-LAN devices.

Informations sur IC (pour les clients canadiens)**APPAREIL****CONTIENT MODULE ÉMETTEUR IC:****6132A-LUXASTR01, 6132A-LUXABT01**

Cet appareil est conforme à la norme CNR-247 du Canada. L'utilisation de ce dispositif est autorisée seulement aux deux conditions suivantes : (1) il ne doit pas produire de brouillage, et (2) l'utilisateur du dispositif doit être prêt à accepter tout brouillage radioélectrique reçu, même si ce brouillage est susceptible de compromettre le fonctionnement du dispositif. Cet appareil numérique de la classe B est conforme à la norme NMB-003 du Canada.

For Canadian customers / Pour les clients canadiens: CAN ICES-3 (B) / NMB-3 (B) "for indoor use only"**ATTENTION**

Afin de réduire le risque d'interférence aux autres utilisateurs, il faut choisir le type d'antenne et son gain de façon à ce que la puissance isotrope rayonnée équivale (p.i.r.e.) ne soit pas supérieure au niveau requis pour l'obtention d'une communication satisfaisante.

(i) les dispositifs fonctionnant dans la bande 5150-5250 MHz sont réservés uniquement pour une utilisation à l'intérieur afin de réduire les risques de brouillage préjudiciable aux systèmes de satellites mobiles utilisant les mêmes canaux.

(ii) De plus, les utilisateurs devraient aussi être avisés que les utilisateurs de radars de haute puissance sont désignés utilisateurs principaux (c.-à-d., qu'ils ont la priorité) pour les bandes 5250 – 5350 MHz et 5650 – 5850 MHz et que ces radars pourraient causer du brouillage et/ou des dommages aux dispositifs LAN-EL.

RF Exposure Information

This equipment complies with FCC / IC radiation exposure limits set forth for an uncontrolled environment and meets the FCC radio frequency (RF) Exposure Guidelines in Supplement C to OET65 and RSS-102 of the IC radio frequency (RF) Exposure rules. This equipment has very low levels of RF energy that are deemed to comply without testing of specific absorption ratio (SAR).

Cet équipement est conforme aux normes d'exposition aux radiations FCC / IC définies pour un environnement non contrôlé et satisfait les directives d'exposition à la radiofréquence (RF) dans le supplément C des OET65 et RSS-102 des règles d'exposition à la fréquence radio (RF) IC. Cet équipement a de très faibles niveaux d'énergie RF qui sont jugés conformes sans test de taux d'absorption spécifique (SAR).

Safety Information (for European customers)

Avoid high temperatures. Allow for sufficient heat dispersion when installed in a rack.

Handle the power cord carefully. Hold the plug when unplugging the cord.

Keep the unit free from moisture, water, and dust.

Unplug the power cord when not using the unit for long periods of time.

Do not obstruct the ventilation holes.

Do not let foreign objects into the unit.

Do not let insecticides, benzene, and thinner come in contact with the unit.

Never disassemble or modify the unit in any way.

Ventilation should not be impeded

Ventilation openings with items, such as newspapers, tablecloths or curtains.

Naked flame sources such as lighted candles should not be placed on the unit.

Safety Information (for European customers)

Observe and follow local regulations regarding battery disposal.

Do not expose the unit to dripping or splashing fluids.

Do not place objects filled with liquids, such as vases, on the unit.

Do not handle the mains cord with wet hands. When the switch is in the OFF position, the equipment is not completely switched off from MAINS.

The equipment shall be installed near the power supply so that the power supply is easily accessible.

A note about recycling

This product's packaging materials are recyclable and can be reused. Please dispose of any materials in accordance with the local recycling regulations. When discarding the unit, comply with local rules or regulations.

Batteries should never be thrown away or incinerated but disposed of in accordance with the local regulations concerning battery disposal.

This product and the supplied accessories, excluding the batteries, constitute the applicable product according to the WEEE directive

Correct disposal of this product

These markings indicate that this product should not be disposed with other household waste throughout the EU.



Pb

To prevent possible harm to the environment or human health from uncontrolled waste disposal and to material resources, this product must be disposed of responsibly.

To dispose of your product, please use your local return and collection systems or contact the installer where the product was purchased.

Radio specification (for Europe model):

Type	Frequency Range	Max. RF Power
Bluetooth	2,402-2,480MHz	20dBm
WLAN (2.4GHz)	2,400-2,483.5MHz	20dBm
5GHz Radio	5,150-5,250MHz	23dBm
	5,250-5,350MHz	23dBm
	5,470-5,850MHz	30dBm

Note: The above specifications are based on the RE directive. There is a possibility it can vary by country.

Welcome

Thank you and congratulations...

...for purchasing your Arcam HDA Receiver.

Arcam has been producing specialist audio products of remarkable quality for over three decades and the new Receivers are the latest in a long line of award winning Hi-Fi. The design of the HDA range draws upon all of Arcam's experience as one of the UK's most respected audio companies, to produce Arcam's best performing range of products yet – designed and built to give you years of viewing and listening enjoyment.

This handbook is intended to give you a detailed guide to using the Receiver. It starts by giving advice on installation, moves on to describe how to use the product and finishes with additional information on the more advanced features. Use the contents list shown on this page to guide you to the section of interest.

We hope that your HDA receiver will give you years of trouble-free operation. In the unlikely event of any fault, or if you simply require further information about Arcam products, our network of dealers will be happy to help you. Further information can also be found on the Arcam website at www.arcam.co.uk.

The HDA development team

Contents

Safety Guidelines	EN-2	Decoding Modes	EN-35
Welcome	EN-4	Tuner Operation	EN-37
Before You Begin...	EN-6	Troubleshooting	EN-38
Trademark Acknowledgments	EN-8	Specifications	EN-40
Rear Panel Connections and Controls	EN-9	Worldwide Guarantee	EN-42
Audio/Video Connections	EN-10		
Connection Guide	EN-12		
Radio & Wireless Audio Connectors	EN-13		
Other Connectors	EN-14		
Speakers	EN-15		
Connecting Speakers	EN-16		
Operation	EN-17		
Extended front panel menu	EN-18		
Updating firmware via USB	EN-18		
Front Panel Operation	EN-19		
Remote Control	EN-20	Professional Installation?	
Customising the Remote	EN-22	It may be that the Receiver has been installed and set up as part of your Hi-Fi installation by a qualified Arcam dealer. In this case, you may wish to skip the sections of this handbook dealing with installation and setting up, and move directly to the sections dealing with using the unit. Use the Contents list to guide you to these sections.	
Essential Setup	EN-28	DIY setup?	
Auto Speaker Setup	EN-29	The Receiver is a powerful and sophisticated piece of AV equipment. If you are setting the unit up yourself, it is recommended that you read this handbook thoroughly before beginning. For instance, correct speaker configuration and placement is a key to getting the most out of your Receiver and making sure that all the elements of your system work in harmony.	
Setup Menus	EN-30		
Connecting to a Network	EN-34		

Before You Begin...

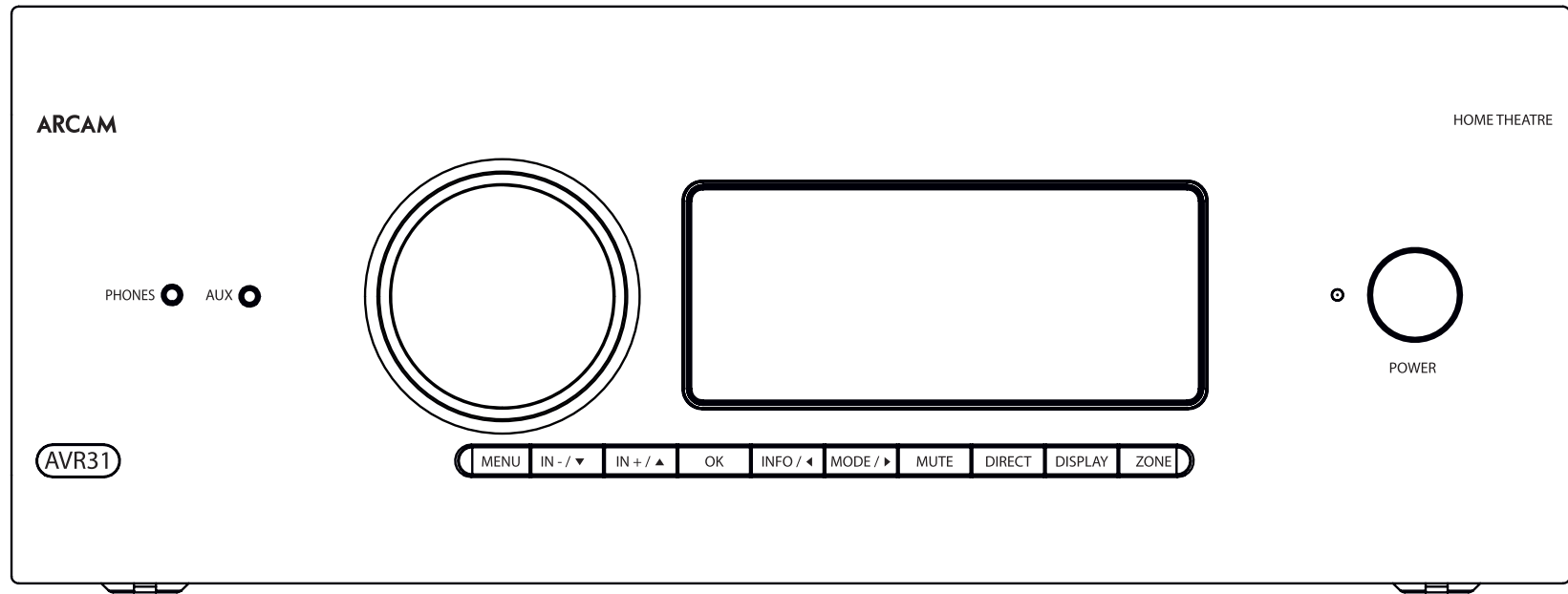

Arcam HDA Receiver

The Receivers are high-quality and high-performance home-cinema processors and amplifiers built to Arcam's quality design and manufacturing standards. They combine digital processing with high-performance audio and video components to bring you an unrivalled home-entertainment centre.

The Receiver allows switching and control of seven analogue and six digital audio sources in addition to internal FM and DAB+ radios – as well as networked audio sources – making any of the models an ideal hub for both home-cinema and two-channel stereo systems.

Since many of these source components are also capable of generating video signals, the Receiver includes broadcast-quality switching for HDMI (7 x HDMI2.1 @ 40Gbit/s, HDCP2.3) video/audio signals. Control of the Receiver is either by front panel control buttons, IR remote control, IP (Ethernet) control or RS232 port.

The remote control supplied with the Receiver is a multi-device 'universal' learning remote control which is simple to use, and once set up is able to control a complete system. It can be programmed using its vast internal code library to control CD and BD players, PVRs, TVs and other devices.

The installation of the Receiver in a listening room is an important process which requires care at every stage. For this reason, the installation information is very comprehensive and should be followed carefully to achieve an unrivalled level of performance.

The Receiver is designed to produce a level of performance that will truly bring music and movies to life.

Placing the unit

- Place the unit on a level, firm surface, avoiding direct sunlight and sources of heat or damp.
- Do not place the Receiver on top of a power amplifier or other source of heat.
- Do not place the amplifier in an enclosed space such as a bookcase or closed cabinet unless there is good provision for ventilation (see page EN-2). The Receiver will run warm during normal operation.
- Do not place any other component or item on top of the amplifier as this may obstruct airflow around the heat-sink, causing the amplifier to run hot. (The unit placed on top of the amplifier would become hot, too.)
- Make sure the remote-control receiver on the front panel display is unobstructed, otherwise this will impair the use of the remote-control. If line-of-sight is impractical, a remote-control repeater can be used with the rear panel connector (see page EN-34).
- Do not place your record deck on top of this unit. Record decks are very sensitive to the noise generated by mains power supplies which will be heard as a background 'hum' if the record deck is too close.

Power

The amplifier is supplied with a moulded mains plug already fitted to the lead. Check that the plug supplied fits your supply – should you require a new mains lead, please contact your Arcam dealer.

If your mains supply voltage or mains plug is different, please contact your Arcam dealer immediately.

The Receiver can be switched for operation between 220–240V (switch position 230V) and 110–120V (switch position 115V).

NOTE: Ensure that the Receiver is switched off and the power lead removed before changing the position of the voltage range switch.

Push the IEC plug end of the power cable into the socket on the back of the amplifier, making sure that it is pushed in firmly. Plug the other end of the cable into your mains socket and, if necessary, switch the socket on.

The Receiver can be turned on using the power switch on the front panel. While switched on, the front panel LED will glow white.

Standby power

The Receiver can be switched into standby mode using the  button on the remote control. While in standby mode the front panel LED will glow red and (with default settings) power consumption is less than 0.5 Watts.

While in Standby mode, it may be possible to hear a slight residual hum coming from the mains transformer inside the amplifier. This is perfectly normal. However, if the unit is to be left unused for an extended period, we recommend that you disconnect it from the mains supply to save power.

Interconnect cables

We recommend the use of high-quality screened cables that are designed for the particular application. Other cables will have different impedance characteristics that will degrade the performance of your system (for example, do not use cabling intended for video use to carry audio signals). All cables should be kept as short as is practically possible.

It is good practice when connecting your equipment to make sure that the mains power-supply cabling is kept as far away as possible from your audio cables. Failure to do so may result in unwanted noise in the audio signals.

For information on speaker cabling, please refer to the 'Speakers' section, beginning on page EN-16.

Radio interference

The Receiver is an audio device containing microprocessors and other digital electronics. Each model has been designed to very high standards of electromagnetic compatibility.







This is a Class A product. In a domestic environment this product may cause radio interference, in which case the user may be required to take adequate measures.





If the Receiver causes interference to radio or television reception (which can be determined by switching the Receiver off and on), the following measures should be taken:

- Re-orient the receiving antenna or route the antenna cable of the affected device as far as possible from the ARCAM Receiver and its cabling.
- Relocate the affected device with respect to the ARCAM Receiver.
- Connect the affected device and the Receiver to different mains outlets.

If the problem persists, please contact your Arcam dealer.

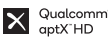
Trademark Acknowledgments

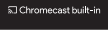
	Dolby Vision, Dolby Atmos, Dolby Audio Manufactured under license from Dolby Laboratories. Dolby, Dolby Vision, Dolby Atmos, Dolby Audio, and the double-D symbol are registered trademarks of Dolby Laboratories.
	DTS:X® For DTS patents, see http://patents.dts.com . Manufactured under license from DTS Licensing Limited. DTS, the Symbol, DTS in combination with the symbol, DTS:X and the DTS:X logo are registered trademarks or trademarks of DTS, Inc. in the United States and/or other countries. © DTS, Inc. All Rights Reserved.
	DTS Virtual:X™ For DTS patents, see http://patents.dts.com . Manufactured under license from DTS Licensing Limited. DTS, the Symbol, DTS and the symbol together, Virtual:X and the DTS Virtual:X logo are registered trademarks and/or trademarks of DTS, Inc. in the United States and/or other countries. © DTS, Inc. All Rights Reserved.
	IMAX® & DTS® Manufactured under license from IMAX Corporation. IMAX® is a registered trademark of IMAX Corporation in the United States and/or other countries. For DTS patents, see http://patents.dts.com . Manufactured under license from DTS Licensing Limited. DTS, the Symbol, DTS and the symbol together are registered trademarks or trademarks of DTS, Inc. in the United States and/or other countries. © DTS, Inc. All Rights Reserved.
	Auro-3D® Manufactured under license from Auro Technologies. Auro, Auro-3D, Auro-Codec and Auro-Matic are registered trademarks of Auro Technologies.
	AAC/AAC Plus aacPlus is a trademark of Coding Technologies. See http://codtech.vhost.noris.net for more information.
	HDMI, the HDMI logo and High-Definition Multimedia Interface are trademarks or registered trademarks of HDMI Licensing LLC.

	The Bluetooth® word mark and logos are registered trademarks owned by the Bluetooth SIG, Inc. and any use of such marks by HARMAN International Industries, Incorporated is under license. Other trademarks and trade names are those of their respective owners.
	Qualcomm is a trademark of Qualcomm Incorporated, registered in the United States and other countries. aptX is a trademark of Qualcomm Technologies International, Ltd., registered in the United States and other countries.
	Apple, AirPlay and the AirPlay logo, iPod, iPhone and iPad are trademarks of Apple Inc., registered in the U.S. and other countries. App Store is a service mark of Apple Inc. AirPlay 2 works with iPhone, iPad, and iPod touch with iOS 11.4 or later, Mac with OS X Mountain Lion or later, and PC with iTunes 10.2.2 or later.
	The Wi-Fi CERTIFIED Logo is certification marks of the Wi-Fi Alliance.
	Google, Google Play, Chromecast, and other related marks are trademarks of Google LLC. The Google Assistant requires an internet connection and is not available in certain countries and languages. Availability and react of certain features and services are device, service, and network-dependent and may not be available in all areas. Controlling certain devices in your home requires compatible smart devices. Subscriptions for services and applications may be required and additional terms, conditions and/or charges may apply.
vTuner	This product is protected by certain intellectual property rights of NEMS and BridgeCo. Use or distribution of such technology outside of this product is prohibited without a license from NEMS and BridgeCo or an authorized subsidiary.
MP3	MPEG Layer-3 audio decoding technology licensed from Fraunhofer IIS and Thomson multimedia.
	Licenses: The Spotify software is subject to third party licenses found here: https://developer.spotify.com/legal/third-party-licenses/

FLAC	FLAC Decoder Copyright © 2000, 2001, 2002, 2003, 2004, 2005, 2006, 2007, 2008 Josh Coalson Redistribution and use in source and binary forms, with or without modification, are permitted provided that the following conditions are met: - Redistributions of source code must retain the above copyright notice, this list of conditions and the following disclaimer. - Redistributions in binary form must reproduce the above copyright notice, this list of conditions and the following disclaimer in the documentation and/or other materials provided with the distribution. - Neither the name of the Xiph.org Foundation nor the names of its contributors may be used to endorse or promote products derived from this software without specific prior written permission. THIS SOFTWARE IS PROVIDED BY THE COPYRIGHT HOLDERS AND CONTRIBUTORS 'AS IS' AND ANY EXPRESS OR IMPLIED WARRANTIES, INCLUDING, BUT NOT LIMITED TO, THE IMPLIED WARRANTIES OF MERCHANTABILITY AND FITNESS FOR A PARTICULAR PURPOSE ARE DISCLAIMED. IN NO EVENT SHALL THE FOUNDATION OR CONTRIBUTORS BE LIABLE FOR ANY DIRECT, INDIRECT, INCIDENTAL, SPECIAL, EXEMPLARY, OR CONSEQUENTIAL DAMAGES (INCLUDING, BUT NOT LIMITED TO, PROCUREMENT OF SUBSTITUTE GOODS OR SERVICES; LOSS OF USE, DATA, OR PROFITS; OR BUSINESS INTERRUPTION) HOWEVER CAUSED AND ON ANY THEORY OF LIABILITY, WHETHER IN CONTRACT, STRICT LIABILITY, OR TORT (INCLUDING NEGLIGENCE OR OTHERWISE) ARISING IN ANY WAY OUT OF THE USE OF THIS SOFTWARE, EVEN IF ADVISED OF THE POSSIBILITY OF SUCH DAMAGE.
-------------	---

	MQA (Master Quality Authenticated) MQA is an award-winning British technology that delivers the sound of the original master recording. The master MQA file is fully authenticated and is small enough to stream or download. Visit mqa.co.uk for more information. Arcam AVRs include MQA technology, which enables you to play back MQA audio files and streams, delivering the sound of the original master recording. 'MQA' or 'MQA Studio' indicates that the product is decoding and playing an MQA stream or file, and denotes provenance to ensure that the sound is identical to that of the source material. 'MQA Studio' indicates it is playing an MQA Studio file, which has either been approved in the studio by the artist/producer or has been verified by the copyright owner. MQA and the Sound Wave Device are registered trade marks of MQA Limited. © 2016
---	--

Rear Panel Connections and Controls

! Please read the 'Placing the unit', 'Power' and 'Interconnect cables' sections on page EN-7 before connecting up your Receiver!

- AVR31
- AVR21
- AVR11

(Ch13-16 & Zone2
AVR21, AVR31, AV41)

NETWORK CONNECTORS

For information, see page EN-13, EN-14.

HDMI CONNECTORS

For information, see page EN-10.

USB SOCKET

See page EN-14.

PREAMPLIFIER INPUTS

See page EN-11.

FM/DAB

FM aerial socket, or DAB aerial socket.

DIGITAL CONNECTORS

Coaxial and optical digital audio connectors, see page EN-11.

NETWORK/BLUETOOTH CONNECTORS

For information, see page EN-13,

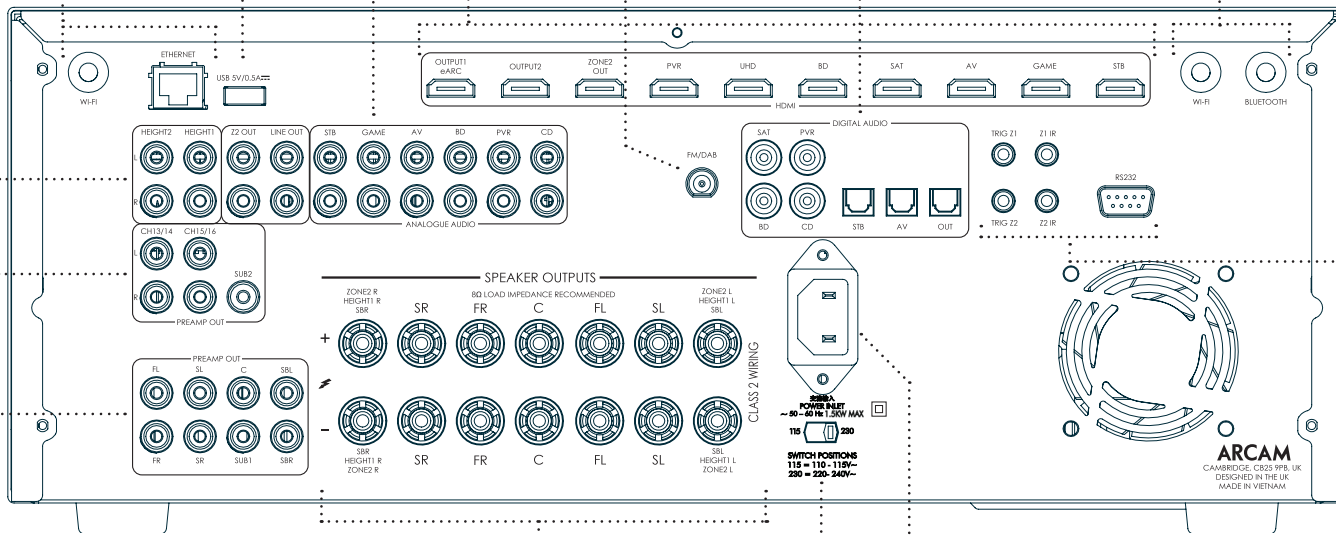

SERIAL AND IR CONTROL
Serial control, trigger and IR connectors, see page EN-14.

PREAMPLIFIER OUTPUTS
See page EN-11.

SPEAKER CONNECTORS
For information, see page EN-16.

POWER INLET
Connect the correct mains cable here

VOLTAGE SELECT
Ensure the voltage selected matches your local power supply.

AV41

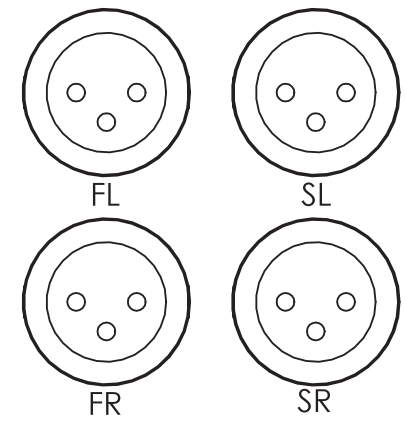

Audio/Video Connections

Before connecting your Receiver to your source components and speakers, please read through the next few pages which will explain all the input and output connectivity that is available. The 'Speakers' section explains how to connect up your speakers to avoid damage to the amplifier and how to arrange your speakers for best performance.

General

The inputs are named to make it easier to reference connected devices (e.g. **BD** or **UHD**). They all have the same input circuit, so there is no reason why you should not connect a different device to any of the inputs. For example, if you had two BD players and the AV input was not being used, then the second BD player could be connected to the AV input.

When connecting a video source, its audio must be connected to the corresponding sockets. For example, if you had a satellite decoder plugged into a **SAT** video input, the audio must be connected to the **SAT** audio inputs!

Making Connections

- Take care to place cables as far from any power supply cabling as is practicable, to reduce hum and other noise problems.

NOTE: For each input, you must set the 'Video Source' and 'Audio Source' settings according to the connection type. (see "Input Config." on page EN-31)

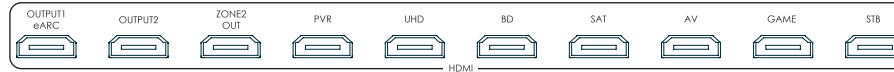

HDMI Connectors

PVR, UHD, BD, SAT, AV, GAME, STB

Connect the HDMI video outputs of your source equipment to these corresponding HDMI inputs.

OUTPUT (Zone2 – AVR21, AVR31, AV41)

Connect this output to the HDMI video input of your display device. Output1 is compatible with HDMI Enhanced Audio Return Channel (eARC). If you have a supported television then sound from the television's internal tuner (e.g. Freeview, Freesat, DVB-T) will be available using the Receiver's 'Display' input.

Digital audio connectors

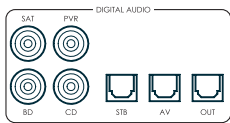

SAT, PVR, BD, CD, STB, AV

Connect these inputs to the digital outputs of your available source equipment.

Zone 2 connectors (AVR21, AVR31, AV41)

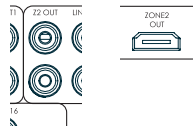

The Z2 out HDMI connector can be used to connect the output of the Receiver to a system located in a second room.

Analogue preamplifier outputs

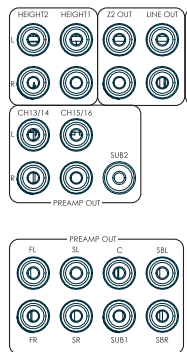

All preamplifier analogue outputs are buffered, have a low output impedance, are at line level and follow the Zone 1 volume control setting. They are able to drive long cables or several inputs in parallel if required.

For more information on connecting speakers or additional power amplifiers, see pages EN-9 and EN-16.

The AV41 has XLR outputs in addition to the phono pre-outs for connection to an external amplifier.

Analogue audio inputs

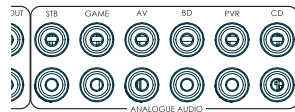

STB, GAME, AV, BD, PVR, CD

Connect the left and right inputs to the left and right outputs of your source equipment.

Front panel AUX input



The front panel **AUX** input can be used as an analogue input, using a stereo 3.5mm lead.

Front panel PHONES socket

This socket accepts headphones with an impedance rating between 32Ω and 600Ω, fitted with a 3.5mm stereo jack plug. The headphone socket is always active, except when Receiver is muted.

When the headphone jack is inserted, the speaker outputs and analogue preamplifier outputs are automatically muted.

Connection Guide

Blu-ray Disc (BD)/DVD player

The diagram shows how to make audio and video connections from a typical BD/DVD player.

Whether HDMI, digital or analogue connections are used, connecting using the input/inputs labelled **BD** on the Receiver will aid in operation.

Satellite receiver

A satellite receiver is connected with the same order of preference according to the outputs provided by the satellite receiver.

CD player

Connect the digital output to the digital **CD** input of the Receiver and analogue output to the analogue **CD** input of the Receiver, using a high quality interconnect cable.

NOTE: For each input, you must set the 'Audio Source' setting according to the connection type. (see "Input Config." on page EN-31)

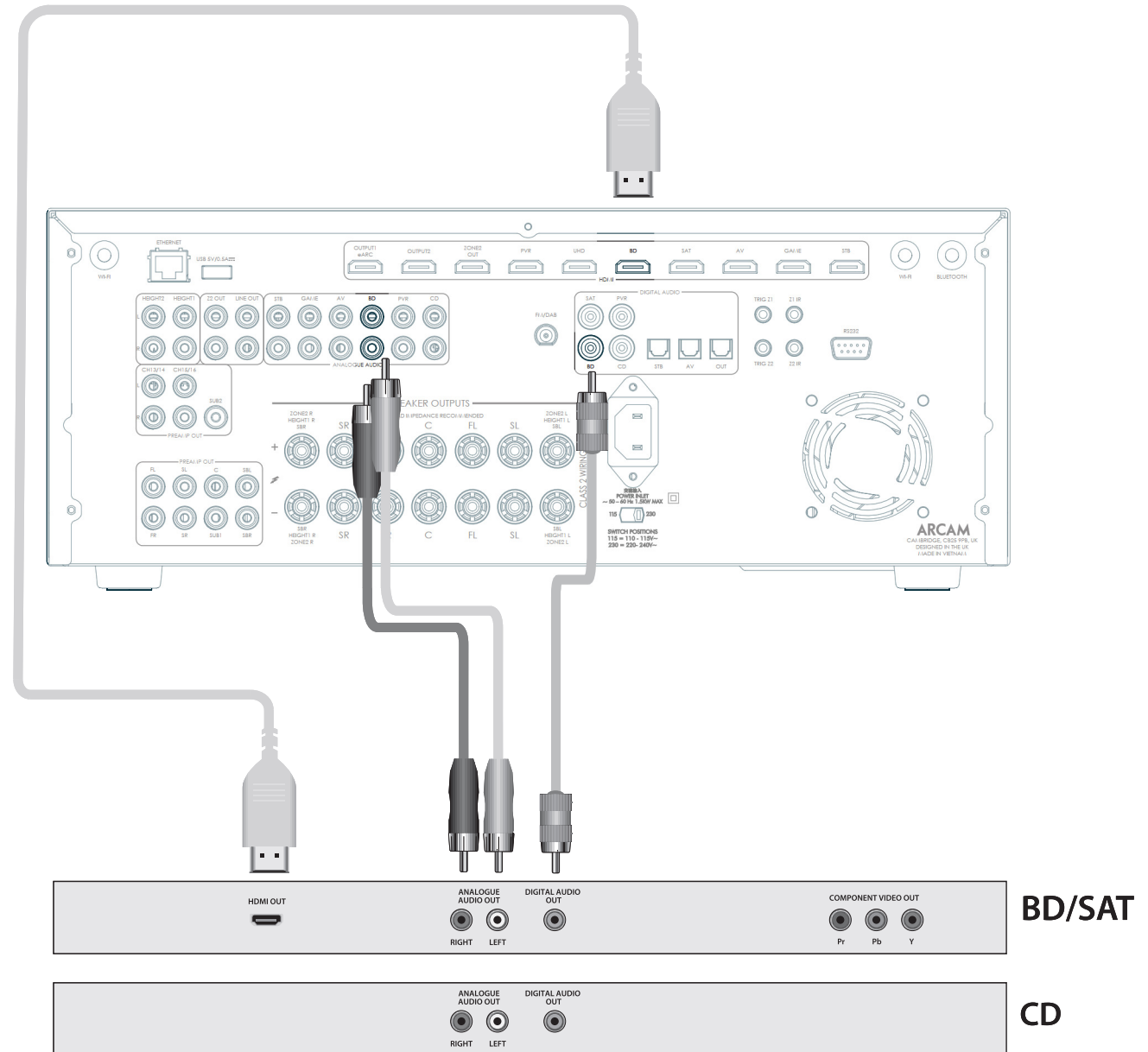

Radio & Wireless Audio Connectors

DAB/FM Connector

The Receiver is fitted with an FM and a DAB/DAB+ receiver module. The type of aerial you need depends on your listening preferences and the local conditions.

Your Receiver is capable of superb radio reception, but only if it is receiving a good quality transmission signal.

Try the aerials supplied with your unit. If you are in a medium to strong signal area, these should be adequate for good reception. In areas with poor signal strength, you may require a roof or loft mounted aerial.

Contact your local Arcam dealer or aerial installation experts for advice about local reception conditions.

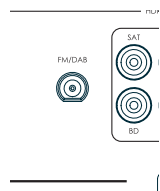

In strong signal areas, the DAB/FM 'T' wire aerial supplied can be used with reasonable results. Mount the aerial as high up as possible on a wall.

In the UK the 'T'-elements need to be positioned vertically for DAB reception since broadcasts are vertically polarised. In other localities, check with your Arcam dealer or try both horizontal and vertical positions for best reception.

Try each usable wall of the room to see which gives best reception and use tacks or adhesive tape to secure the aerial in a 'T' shape, but note that no tacks should come into contact with the internal wire of the aerial.

When installed and receiving DAB/FM, check the signal strength by pressing the front panel or remote control's **INFO** button until the signal quality indicator is displayed.

In weak signal areas, a high-gain, externally-mounted or roof-mounted aerial is desirable in order to receive the highest number of services.

In Band III transmission areas (such as the UK), use a multi-element Yagi aerial with the elements mounted vertically, as the transmissions are vertically polarised. If you are close to more than one transmitter, use an omnidirectional or folded dipole aerial.

If the DAB services in your area are transmitted on L-band, then ask your dealer for advice for the best aerial to use.

Wi-Fi/Bluetooth

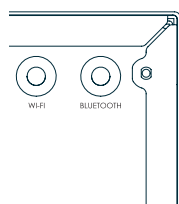

If using the Wi-Fi or Bluetooth features of the Receiver, please attach the single antenna for the Bluetooth and the two antennas for the Wi-Fi.

Other Connectors

Serial connector

RS232 serial connector

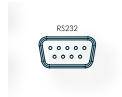

The connector is used with control devices having an RS232 serial port (for example, Crestron and AMX touch-screen controllers).

Network connector

Networking is a large subject and only the briefest guidelines are presented in this handbook. Please contact your Arcam dealer or specialist installer for more information about introducing the Receiver into your computer network.

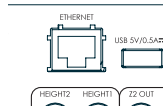

Ethernet

If an Ethernet cable is connected, the Receiver will automatically attempt to connect to your network.

You should use CAT5 cable plugged into the RJ45 socket labelled **ETHERNET** on the rear panel.

If your network uses static IP addressing rather than DHCP, you will need to provide IP address, gateway and DNS; see page EN-34 for information on setting up the network.

USB connector

The Receiver can be updated via the USB socket on the rear of the unit, if no network connection and so "Over The Air" update is not available.

Trigger connectors

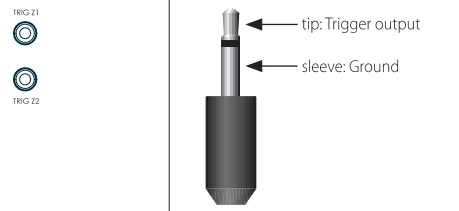

The trigger connectors (**TRIG Z1** and **TRIG Z2**) provide an electrical signal whenever the Receiver is switched on and the relevant zone enabled.

The trigger signal can be used to switch on and off compatible pieces of home entertainment equipment, for example, you could set up a trigger to turn on your television and BD player whenever the Receiver was switched on.

There are two trigger output sockets on the Receiver, each capable of outputting a 12V, 70mA switching signal. The socket is designed for mono 3.5mm jacks: tip is the trigger output, sleeve is ground.

TRIG Z1

Use for remotely turning on and off power amps or source equipment for Zone 1. On = 12V, Off = 0V.

TRIG Z2 (AVR21, AVR31, AV41)

Use for remotely turning on and off power amps or source equipment for Zone 2. On = 12V, Off = 0V.

Infrared (IR) connectors

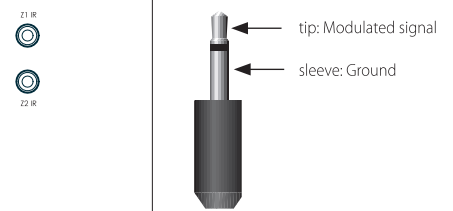

The infrared inputs (**Z1 IR** and **Z2 IR**) allow the connection of external IR receivers, either when the Receiver front panel IR receiver is fully or partially obstructed or to allow the use of a remote control in Zone 2.

There are two IR inputs on the Receiver, each designed for stereo or mono 3.5mm jacks. Tip is the modulated signal, sleeve is ground.

Z1 IR

This input is intended for use with a local IR receiver when the front panel of the Receiver is blocked.

Z2 IR (AVR21, AVR31, AV41)

This input is intended for use with an IR receiver in Zone 2 to allow remote control of Receiver from a second room.

A supplier of infra-red receivers and emitter accessories and systems is Xantech. See www.xantech.com for more information, or ask your Arcam dealer.

NOTE: The IR inputs on the Receiver are designed for modulated signals. If the external IR receiver demodulates the IR signal, it will not work. Also the unit does not provide power for external receivers on the IR jack, therefore an external power source will be required.

NOTE: Sockets referring to 'Z2' relate to connections used in multi-room installation. For more information on these connectors, see page EN-11.

Speakers

The AVR5/AVR11/AVR21/AVR31/AV41 allows you to connect up to sixteen speakers. The AV41 is designed to be used with additional power amplifiers for all channels. The AVR5/AVR11/AVR21/AVR31 has 7 channels of amplification. 5 channels of amplification correspond to speakers installed in the front left, centre, front right, surround left, surround right. The remaining 2 channels of amplification can be assigned as:

- bi-amp the front left and right
- surround back left and surround back right
- height 1 left and right
- Zone 2 left and right (AVR21, AVR31, AV41)

Height front left, height front right, height back left, height back right and five more additional speakers can be attached using an additional power amplifier, see page EN-16 for more information.

With the addition of correctly installed and configured height channels, Dolby Atmos for the home, DTS:X or Auro 3D brings the ultimate cinema sound experience to your home theatre to create powerful, moving audio that flows around you.

The configuration and placement of your speakers is very important. All speakers, with the exception of the subwoofer(s), should be arranged around your normal viewing/listening position. The subwoofer should be placed in a position which gives an even frequency response in all listening positions. Incorrect placement leads to bass boom in some areas. Often the only way to find a good position for your subwoofer(s) is by experimentation. A good place to start experimenting is close to a wall but at least 1m away from any corners. You can also consult your subwoofer handbook for placement suggestions.

Connecting Speakers

To connect each of the speakers, unscrew the corresponding terminals on the back of the Receiver, insert the speaker wires through the hole in each post and screw the terminals back up. Make sure that the red (positive/+) terminal of the speaker is connected to the red (positive/+) terminal on the back panel, and the black (negative/-) terminal of the speaker is connected to the black (negative/-) terminal on the back panel.

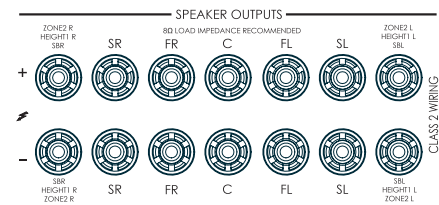

It is important that no stray strands of wire from these connections are allowed to touch another cable or the product casing. Failure to ensure this can cause a short circuit and damage your Receiver.

Ensure the unit is switched off whilst connecting speakers. Do not over-tighten the loudspeaker terminals, or use a wrench, pliers, etc., as this could damage the terminals and this would not be covered under the product's warranty.

Speaker cables

The speakers should be connected to the amplifier using good-quality, high-purity, low impedance copper cables. Cheap speaker cables should be avoided – they are a false economy and can significantly degrade the sound quality.

The cable runs to the speakers should be as short as practicable. Connections to the speaker terminals should always be finger tight, whether using bare wires or spade connectors.

Bi-amping the Front Left & Front Right speakers

Bi-amping is the use of two amplifier channels per speaker. Bi-amping can provide better sound quality than conventional single wiring. If you do not have Surround Back speakers (i.e. you have a 5.1 surround system, not a 7.1 system) then you can use the spare Surround Back speaker outputs to bi-amplify the front left and right speakers, if your speakers support bi-amping. The spare channels can alternatively be used to power stereo speakers in another room (Zone 2).

Speakers that support bi-amping have two sets of +/- terminals per speaker, usually linked together by metal strips. These metal strips **MUST** be removed when bi-amping; failure to remove them will result in damage to the amplifier that is not covered under warranty.

To bi-amp the front left and right speakers, remove the metal strips from the speaker terminals. Connect the woofer or LF terminals to the FL and FR terminals on the Receiver. Finally, navigate to the Setup Menu 'Spkr Types' and set the 'Use Channels 6+7' menu option to 'BiAmp L+R'; see page EN-32.

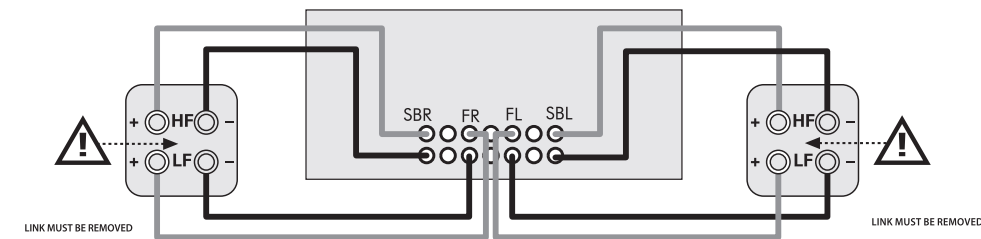

Connecting Subwoofers

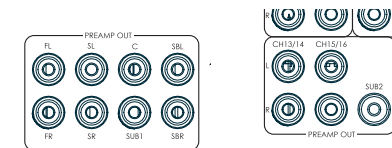

The Receiver also allows up to four active subwoofers to be connected to the **SUB** or **Ch13/14/15/16** outputs. Refer to your subwoofer handbook for the correct setting up and connection procedure for your particular subwoofer(s).

Using external power amplifiers

The internal power amplifier of the Receiver can be supplemented or replaced with external power amplification, such as the Arcam PA720. Connect the **PREAMP OUT** sockets to your power amplifier inputs:

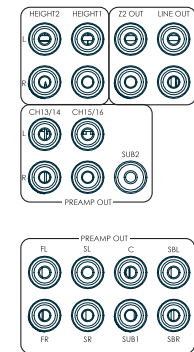

FL, FR

Connect these to the equivalent Right and Left front channels of your power amplifier.

C

Connect these to the Centre front channel of your power amplifier.

SUB

Subwoofer outputs. Connect this to the input of your active subwoofer(s), if present.

SR, SL

Surround Right and Surround Left outputs. Connect these to the Surround Right and Left power amplifier inputs.

SBR, SBL

Surround Back Right and Surround Back Left outputs. Connect these to the Surround Back Right and Surround Back Left power amplifier inputs.

Height 1 (Height Front), Height 2 (Height Back)

Height Front and Height Back. Connect these to the Height channel power amplifier inputs.

All preamplifier analogue outputs are buffered, have a low output impedance and are at line level. They are able to drive long cables or several inputs in parallel if required.

Operation

Operating your Receiver

For information display we recommend you use the OSD (On-Screen Display) on your display device whenever possible.

Switching on

Press the front panel power button in. The power LED will glow white. When initialisation is complete, the display shows the volume setting and the name of the selected input.

Please wait until the unit has finished initialising before operating the Receiver. It is recommended that if the unit is switched off, you should wait at least 10 seconds before switching the unit back on.

Standby

The Receiver has a standby mode which can be entered by pressing **STANDBY** on the remote control. When in standby mode, the display is blank and the **POWER** LED glows red.

If the unit is to be left unused for an extended period, we recommend that you disconnect it from the mains supply to save power.

To switch on from standby

Press the **STANDBY** button on the remote control, any key on the front panel (other than the power button) or rotate the volume knob.

Front panel display

The Receiver is ready for use after about four seconds.

The display window shows the currently selected source and the last selected information view setting (this information line can be changed using the **INFO** button).

The current volume setting for Zone 1 is displayed on the front panel. The volume setting for Zone 2 is displayed temporarily whenever it is adjusted.

The front panel display is also used for unit setup after pressing the **MENU** key on the front panel or remote.

Selecting a source

To select a particular source, press the **INPUT-** or **INPUT+** buttons until that source is shown on the front panel display, or (if available) press the corresponding source button on the remote. The following sources are available:

STB	Set Top Box input
GAME	Game console input
AV	Audio-Visual input
SAT	Satellite input
BD	Blu-ray Disc/DVD player input
UHD	UHD player input
PVR	Personal Video Recorder input
CD	Compact Disc player input
FM	Internal tuner input
DAB	Internal tuner input (this source is market dependent and may not be available on your Receiver)
NET	Ethernet input
BT	BT input
AUX	Auxiliary (front panel) input
DISPLAY	The Audio Return Channel (eARC) from a compliant display. Use this with a compliant television using internal TV tuners.

Most audio inputs have both analogue and digital connections. You must specify the type of connection used for each input using the '**Audio Source**' option in the 'Input Config.' menu, see page EN-31. Note that an incorrect setting will result in no sound — the default for inputs with HDMI is HDMI audio. If you are not using HDMI audio then this setting must be changed. For inputs that do not have HDMI, the default is digital audio.

The processing mode and Stereo Direct functions are remembered and recalled for each individual input.

Stereo Direct

To listen to a pure analogue stereo input, press the **DIRECT** button. The Stereo Direct mode automatically bypasses all processing and any surround functions. In direct mode, digital processing is shut down to improve the sound quality and reduces digital noise with the Receiver to an absolute minimum.

Note: when Stereo Direct mode is selected, no bass management is performed, meaning that bass signals will not be redirected to a subwoofer.

Volume control

It is important to realise that the level of the volume indicator is not an accurate indication of the power delivered to your loudspeakers. The Receiver often delivers its full output power long before the volume control reaches its maximum position, particularly when listening to heavily recorded music. In comparison, some movie sound tracks can appear very quiet, as many directors like to keep maximum levels in reserve for special effects sequences.

Headphones

To use headphones with the Receiver, plug the headphones into the **PHONES** socket in the centre of the front panel.

When headphones are plugged into the front panel **PHONES** socket, the outputs for Zone 1 are muted and the audio will be down-mixed to two channels (2.0). The two-channel down-mix is required so that the centre channel and surround information can be heard via the headphones.

Extended front panel menu

Pressing the **MENU** key on the front panel and holding it for longer than four seconds will bring up the Extended Menu, allowing you to perform the following:

Restore to factory defaults

This option allows you to restore all settings on your Receiver to the defaults that it left the factory with.

Check for update

Checks for an over-the-air firmware update (requires external network connection).

Restore secure backup

This option allows you to restore all settings to their state as saved using the 'Store secure backup' feature. This option is useful if settings are accidentally changed.

Store secure backup

This option allows you to save all the Receiver settings to a secure area of memory. The settings can be retrieved using the Restore option above.

Restore USB backup

This option allows you to restore all the settings from a file previously saved on a USB flash drive.

Store USB backup

This option allows you to save all the settings to a USB flash drive.

Region

Sets the region you are located - Europe, (RoW) US or Canada.

Change remote code

The default RC5 system code the Receiver responds to is 16. If required, for example due to another device in your system also using this RC5 system code, it can be changed to 19. The supplied remote can also be reprogrammed to use RC5 system code 19 commands, see page EN-22.

Standby mode

"Auto" uses the power-saving auto-standby feature, which will cause the unit to go into standby after 20 minutes if no signal is present or user input occurs, "manual" allows the user full control of when the unit goes into standby.

Protection sensitivity

This option allows adjustment of the protection sensitivity of the power amplifier (not AV41). Caution should be used with this setting as it is deliberately configured for maximum protection and should only be adjusted when using speakers that are "complex loads"!

Use display HDMI

If set to "no" the Receiver will ignore the EDID of the display and send all resolutions from the source through the Receiver.

Display type

Adjusts the position of the OSD depending on if a 16:9 & 21:9 display is being used.

Updating firmware via USB

The firmware in your Receiver can be updated from a USB flash drive containing firmware update files.

You can download the latest firmware file, together with upgrading instructions, from the Arcam website (www.arcam.co.uk).

Front Panel Operation

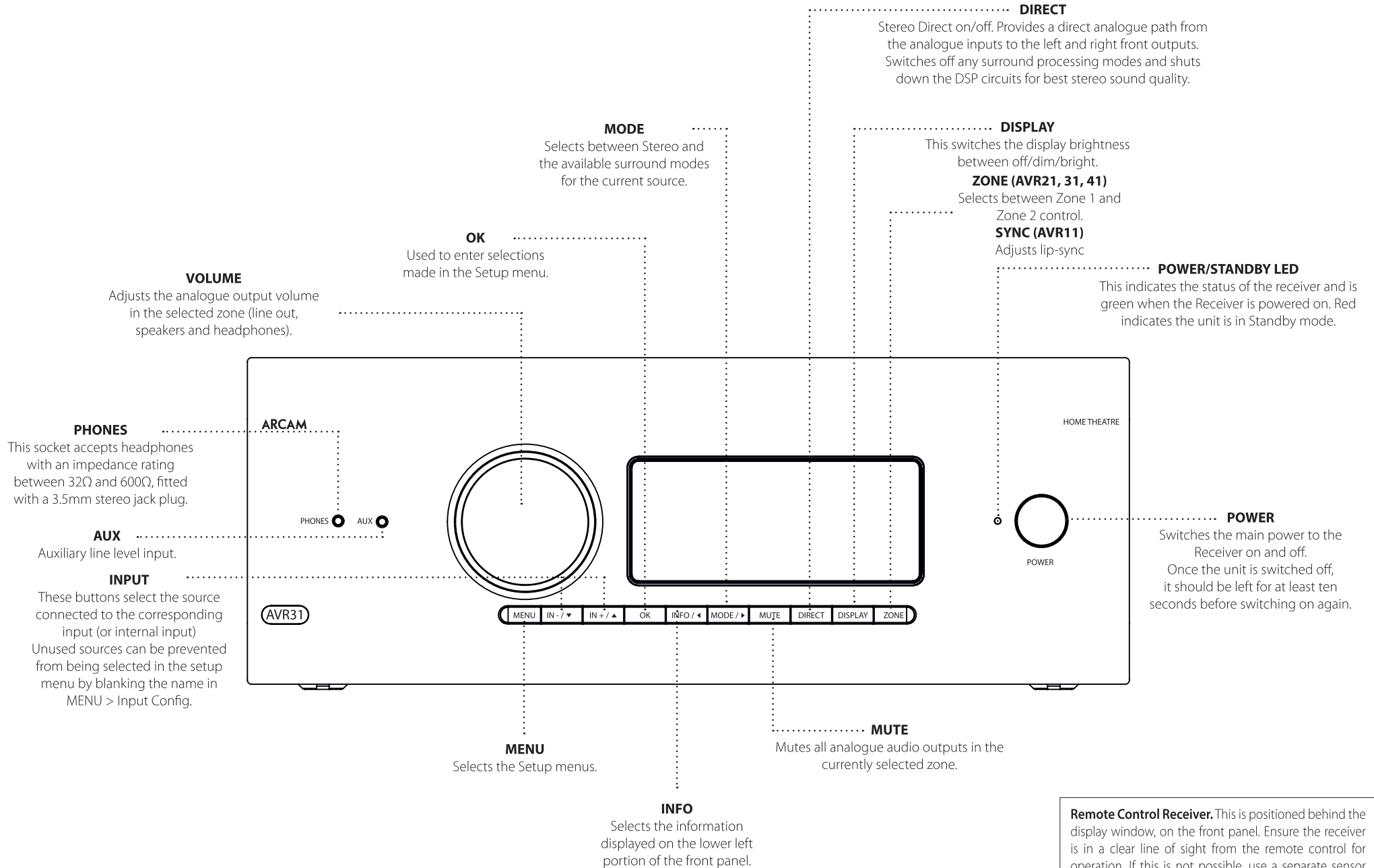

Remote Control Receiver. This is positioned behind the display window, on the front panel. Ensure the receiver is in a clear line of sight from the remote control for operation. If this is not possible, use a separate sensor connected to the **Z1 IR** input on the rear panel.

Remote Control

The universal remote controller

The Receiver is supplied with a sophisticated 'universal' backlit remote control that can control up to eight devices. It is pre-programmed for use with the Receiver and many other Arcam products (FM/DAB tuners, CD players and BD players).

With its extensive built-in library of codes, it can also be used with thousands of third party audio-visual components – TVs, satellite and set-top boxes, PVRs, CD players, etc. See the list of codes at the back of this handbook.

It is also a 'learning' remote, so you can teach it almost any function from an old single-device remote.

Using the remote control

Please keep in mind the following when using the remote control:

- Ensure there are no obstacles between the remote control and the remote sensor on the Receiver. The remote has a range of about 7 metres. (If the remote sensor is obscured, the Z1 IR remote control input jack on the rear panel is available. Please consult your dealer for further information.)
- Remote operation may become unreliable if strong sunlight or fluorescent light is shining on the remote sensor of the Receiver.
- Replace the batteries when you notice a reduction in the operating range of the remote control.



Inserting batteries into the remote control

1. Open the battery compartment on the back of the handset. To do this, press the catch on the battery cover as indicated by the arrow on the catch and remove the battery cover.
2. Insert two 'AAA' batteries, as indicated in the battery compartment.
3. Replace the battery cover. To do this, locate the lug on the battery cover into the corresponding hole on the short edge of the battery compartment. Now press the opposite end of the battery cover (with the catch) down so that the cover is flush with the main body of the remote and the catch clicks.

Notes on batteries:

- Incorrect use of batteries can result in hazards such as leakage and bursting.
- Do not mix old and new batteries together.
- Do not use non-identical batteries together – although they may look similar, different batteries may have different voltages.
- Ensure the plus (+) and minus (-) ends of each battery match the direction indicated in the battery compartment.
- Remove batteries from equipment that is not going to be used for a month or more.
- When disposing of used batteries, please comply with governmental or local regulations that apply in your country or area.

Useful information

Backlight

A backlight comes on for eight seconds whenever a key is pressed. This helps you use the handset in subdued lighting conditions.

LED blinks

Short blinks indicate a valid key press.

Multiple short blinks convey information (such as a device code) or signal the beginning and successful completion of a programming sequence.

The symbol  is used in the manual to indicate an LED blink.

Timeouts and unassigned keys

Time out – After 30 seconds the remote exits the programming state and returns to normal operation.

Stuck key timeout – After any key is pressed continuously for 30 seconds, the remote stops sending IR transmission to conserve battery life. The remote remains off until all keys are released.

Unassigned keys – the remote ignores any unassigned key presses for a particular Device Mode and does not transmit IR.

Low voltage indicator

When the batteries are running down, the backlight flashes briefly whenever you press a button.

If this happens, fit two new AAA alkaline batteries as soon as possible.

Device Mode/Source keys

As the remote can control your Receiver as well as a range of other equipment: many of the buttons have more than one function depending on the 'device mode' selected on the remote control.

The Device Mode keys (shown below) select the source on the Receiver. If one of these keys is pressed briefly, a command is transmitted to change the source on the unit. Also the functionality of the remote control changes to operate the selected source device; it's like having a bundle of different remotes in your hand!



	Internal FM or DAB tuner input
	Auxiliary input
	Ethernet input (e.g. Internet radio)
	Bluetooth input
	Audio-visual input
	Satellite input
	Personal Video Recorder (or Digital Video Recorder) input
	Games console input
	Blu-ray Disc or DVD player
	Compact Disc player input
	Set Top Box decoder input
	UHD player input

Each Device Mode changes the behaviour of many of the remote keys to control the source device appropriately. For example: in **CD** mode plays the previous CD track, but in **AV** mode issues the TV 'channel down' command.

The remote remains in the last selected Device Mode so it is not necessary to press a Device Mode key before every command key if all you are doing is playing or skipping tracks on a CD, for example.

Navigation keys



The Navigation keys steer the cursor in Setup menus or on-screen menus. They also replicate the navigation functions of original remotes supplied with other home entertainment devices in your system. **OK** confirms a setting.

Volume control

By default, the remote is set up so that the volume control and mute buttons always control the volume of the Receiver, regardless of which Device Mode the remote is currently set for. This is known as volume 'punch through'.

For example, if you are listening to a CD, you will probably have the remote in **CD** Device Mode to control the CD player. You can use the volume controls on the remote directly to adjust the volume of the Receiver without first having to press **AMP** to put the remote into **AMP** Device Mode. The volume buttons 'punch through' the **CD** Device Mode on the remote to the **AMP** Device Mode.

Volume 'punch through' can be disabled individually for any Device Mode if desired.

Customising the remote

The remote offers a Code Learning feature that allows you to copy up to 16 functions from an original remote control onto the remote keypad. For details of this, and other customisation features, see "Customising the Remote" on page EN-22.

The remote complies with Part 15 of the FCC rules

This equipment has been tested and found to comply with the limits for a class B digital device, pursuant to part 15 of the FCC Rules. These limits are designed to provide a reasonable protection against harmful interference in a residential installation. This equipment generates, uses, and can radiate radio frequency energy and if not installed and used in accordance with the instructions, may cause harmful interference to radio communications. However, there is no guarantee that interference will not occur in a particular installation. If this equipment does cause harmful interference to radio or television reception, which can be determined by turning the equipment off and on, the user is encouraged to try to correct the interference by one or more of the following measures:

- Reorient or relocate the receiving antenna.
- Increase the separation between the equipment and receiver.
- Connect the equipment into an outlet or a circuit different from that to which the receiver is connected.
- Consult the dealer or an experienced radio/TV technician for help.

Customising the Remote

Code learning

The supplied remote comes with a complete library of pre-programmed codes. After you have set up the remote for your device, you may find that there are one or more functions on your original remote which do not have a place on the keypad. For convenience, the remote offers a Code Learning feature that allows you to copy up to 16 functions from an original remote control onto the remote keypad.

Before you start, make sure that:

- The original remote control is working correctly.
- The remotes are not pointing at your device.
- The remotes have fresh batteries.
- The remotes are not in direct sunlight or under strong fluorescent lights.

NOTE

Learned functions are mode-dependent. You could assign up to eight different functions to a single key – a separate learned function for each mode.

Direct code setup (Method 1)

The first method is to program the remote with the 3-digit code number for the device you wish to control – see “device code tables”. Make a note of the suggested number or numbers – the most popular code is listed first. Now power on the device.

1. Press the Device key for the product you want to set up, together with the **1** key. Hold down both buttons for three seconds until the LED stays lit.

You are now in setup mode, and you can release the buttons.

2. Enter a 3-digit code for the device.

If the 3-digit code number you entered is correct for the device, it will turn off. If it doesn't turn off, enter the next code number from your list until the device does turn off.

3. Once you have found the correct code, press the Device key again. The LED blinks three times  to confirm that the code has been successfully stored.





NOTE

On the following pages, a single ‘blink’ of the remote’s power LED is indicated by the symbol .

Library search setup (Method 2)



Library search allows you to scan through all the codes contained in the remote’s memory. It can take a lot longer than the previous method, so only use this method if:

- Your device does not respond to the remote after you have tried all the codes listed for your brand.
- Your brand is not listed at all in the Device Code tables.

1. Press the Device key for the product you want to set up, together with the **1** key. Hold down both buttons for three seconds until the LED stays lit.
2. Point the remote control at the product you wish to control and press the  or  button on the navigation pad. Each time the  or  button is pressed, the code counts up (or down) one code number with a signal to power off the device.
3. Continue pressing the up or down button, in approximately one second intervals, until the device turns off. (DO NOT alternate the up and down button – you need to move in only one direction.)
4. To store the correct code, press the Device key again. The LED blinks three times  to confirm that the code has been successfully stored.

Learning setup (Method 3)

The third method involves ‘teaching’ the Arcam remote from the original remote for the device. The two remotes should be facing each other, about 10cm apart.

1. Press the Device key for the product you want to set up, together with the **3** key. Hold down both buttons for three seconds until the LED stays lit.
2. Press the button on the Arcam remote that you want to assign a command to. The LED blinks once  indicating that the remote is ready to learn the command.
3. Press and hold the appropriate key on the other remote until the LED blinks twice . This indicates the Arcam remote has learned the command from your other remote.
4. Continue learning the commands from your other remote by pressing the next button on the remote and repeating steps 2 and 3.

5. Once the remote has learned all the selected commands, press and hold the Device key you used to enter learning together with the Numeric **3** key to store the learned commands.

NOTE

If the Arcam remote LED blinks five times  there was an error in the learning process. In this case, please start the Learning Setup from the start.



The AMP and RADIO keys do not learn commands.

Important notes

- Once you start a Code Learning session, you have approximately ten seconds to conduct each step. Any longer, and a timeout means that you'll have to start the process again.
- The Learning feature is mode-specific – you can copy one feature *per mode* onto a key.
- The remote can learn approximately 16 functions in total.
- To replace a learned function, simply assign a new function to the same key.
- Learned functions are retained when you change batteries.
- If Code Learning fails, try altering the distance between the two remotes; make sure that the ambient light is not too bright.

Deleting the learned data

To delete all the learned data for a device:

1. Press the Device key for the product you want to set up, together with the **3** key. Hold down both buttons for three seconds until the LED stays lit.
2. Press and hold down the Device key for the product that you want to erase, together with the **11** key for three seconds until the LED blinks twice .
3. If no further key presses are made for 30 seconds after the LED blinks twice , the remote leaves erase mode without deleting the learned data.

- If you press the Device key together with the **3** key one more time within 30 seconds after LED blinks twice you can finish the erase mode deleting all the data learned on the Device. The LED blinks three times to confirm.

To delete the learned data for a key for a device:

- Press the Device key for the product you want to set up, together with the **3** key. Hold down both buttons for three seconds until the LED stays lit.
- Press and hold down the key on which you want to delete the data for three seconds. The LED blinks twice . If any further key press is made, the remote escapes from erase mode without deleting the learned data.
- If any further key press is not made for 30 seconds, the LED blinks twice , the remote escapes from the erase mode automatically without deleting the learned data.
- If you press the Device key together with the **3** key again within 30 seconds after the LED blinks twice, all the data learned for that Device is deleted and you leave erase mode. The LED blinks three times in confirmation.

Reading stored code numbers

- Press the Device key for the product that you want to set up together with the **4** key. Hold down both keys for three seconds until the LED blinks.
- Press the **INFO** key and count the number of blinks (=1, =2, =3, etc.). There is a time gap between digits. (Note that '0' is represented by ten blinks:)

Locking/Unlocking a specific Device Mode

When you first unpack your remote and insert the batteries, it is able to control certain Arcam components automatically (e.g. BD players, Amplifiers, Tuners and CD Players). We achieve this by programming specific Arcam device codes onto the relevant Device Mode keys, then locking the Device Modes so you don't reprogram them inadvertently.

If you want to override these locked default settings – to control a third-party BD player, for example – you will first need to unlock BD Mode before setting up the remote using one of the learning methods described on the previous page.

Here are the factory default settings:

Device Mode	Default status	Default codes
AMP	Locked	001 (Arcam code 16)
BD	Locked	001 (Arcam)
AV	Unlocked	108 (Philips TV)
UHD	Unlocked	Code learning only
GAME	Unlocked	Code learning only
STB	Unlocked	030 (Bush/Goodmans/Grundig, from SAT database)
SAT	Unlocked	128 (Sky+ Digital, from SAT database)
PVR	Unlocked	018 (Humax PVR, from SAT database)
CD	Locked	001 (Arcam)

Alternative codes are available for multi-room solutions, or in the case of code clashes with other manufacturer's products.

For example:

AMP (system code 19): 002

Note that you need to change the system code on the product you wish to control, as well as the remote.

- AMP, BD and CD are the Device keys that may be Locked or Unlocked.

Lock and Unlock are toggles (they change from Lock to Unlock to Lock, etc.).

- Press and hold the Device and **6** keys together for three seconds.

The power LED stays lit, showing that it is in Lock/Unlock setup mode.

- If there is no further key input for 30 seconds, the LED goes off and the remote leaves Lock/Unlock setup mode.

- To toggle the status of a device and then verify the status of a device, press the **3 6 9** keys in sequence:

If you have locked the device, the LED blinks three times: .

If unlocked the device, the LED blinks five times: .

- If you press a valid Device key within 30 seconds, the LED blinks three times: and the remote leaves Lock/Unlock setup mode.

Controlling the volume of other devices

By default, the volume keys and mute key control the amplifier volume.

You can configure these buttons so they send volume commands to another device. In the following example, the volume commands are sent to a linked AV device (your television, for instance):

- Press **AV + 5** for three seconds, until the LED lights and stays on.
- Press **VOL UP**.
- Press **AV** again. The LED blinks three times .

The volume and mute keys will now send the volume commands to the TV.

To set the volume buttons to control the amplifier once more, repeat the above steps, except press **AMP** in step 3.

Hidden commands

Command	Effect
AMP +	Sends a Power On command
AMP +	Sends a Power Off command
AMP + OK	Sends a Zone command
AMP +	Cycles through HDMI outputs 1, 2, 1&2.
CD +	Sends a Power On command
CD +	Sends a Power Off command
BD +	Sends a Power On command
BD +	Sends a Power Off command
BD +	Sends a Resolution command

Factory default reset

You can reset your remote to the original factory default settings.

Press and hold both the (home) and **MENU** keys for about five seconds until the power LED blinks five times .

All programming and setup codes that you have entered into the remote are erased and the remote returns to the original factory default settings.

Device codes

The tables that are in the final section of this Handbook list 3-figure codes for different manufacturers' devices.

Use these when setting your remote up to control your devices, as described in Direct code setup: Method 1 (see previous page).

If more than one code number is listed, try the first number. If the results are unsatisfactory, continue trying the numbers for that manufacturer to get the best 'fit' with the functionality required.





If the manufacturer of your equipment is not listed, you can try Library search setup: Method 2 (see previous page). This method allows you to scan through every code contained in the remote's memory.



AMP







AMP Device Mode

The **AMP** Device Mode button configures the remote to control the Receiver. Pressing this button does not affect the currently selected input on the Receiver.

The functionality of the remote is context sensitive for the internal sources and is described in the following table.



	Single press – Toggles Receiver power between standby and on in the current zone (zone in which the command is received). Press and hold – Forces all zones into standby, regardless of which zone the command was received in.
0.....9	The number keys can be used for direct entry of numeric values
SYNC	Sync. Delays may be introduced into the video signal by video processing which causes a mismatch between the audio and video timing. You will notice this by speech sound being out of synchronization with the lip movements in the video. To compensate for this, you can adjust the lip sync delay. Press the SYNC button and use the  and  navigation buttons. Press again to exit the lip sync trim menu.
INFO	Info cycles through the information displayed on the lower left portion of the front panel display when on TUN , NET and USB inputs.
	Brings up the DTS:X dialogue control adjustment.
MENU	Displays the unit's setup menu on the On Screen Display.
POP UP	Toggles Dolby Audio Processing.
AUDIO	Toggles Dirac Live EQ on/off.

RTN	Brings up a temporary subwoofer trim control. Use the  and  navigation buttons. Press RTN again to exit the sub trim control. As this is a temporary adjustment, the sub trim level is reset to the value set in the Speaker Levels menu when the unit is turned off or put into standby.
	Toggles the mute function of the AVR.
VOL	Adjust amplifier volume.
MODE	Cycles through the available surround and downmix modes.
DISP	Cycles through the front panel display's brightness options
AMP	Resets remote to AMP mode.
DIRECT	Stereo direct on/off. Provides a direct analogue path from the analogue inputs to the left and right front outputs. Switches off any surround processing modes and shuts down the DSP circuits for the best stereo sound quality.

	Navigate the files and menus on the screen. OK selects the highlighted file or enters the highlighted menu on the screen – equivalent to 'Enter' or 'Select' on some remote controls.  Up  Left  Right  Down AMP +  Power on from standby AMP +  Standby from Power on AMP + OK select Zone 2
RED	Red button.
GREEN	Green button.
YELLOW	Yellow button.
BLUE	Blue button.
RADIO	Tuner input.
AUX	Aux input.
NET	NET input.
BT	BT input.
AV	AV input.
SAT	SAT input.
PVR	PVR input.
GAME	Game console input.
BD	BD input.
CD	CD input.
STB	STB input.
UHD	UHD input.

Network commands









When using the network client, the keys below are used to navigate music files in **AMP** Device Mode.









	Selects the previous/next track in the current playlist.
	Pause and playback of the current track.
	Stops playback.

BD

BD/DVD Device Mode

The **BD** Device Mode button configures the remote to control the functions of Arcam Blu-ray Disc and DVD players, although this can be changed. Pressing this button also selects **BD** as the source.





	Toggles power between standby and on.
	Open/close disc tray.
0...9	Searches for and plays the track corresponding to the key pressed when playing a CD.
DISP	Cycles through the front panel display's brightness options.
MODE	Cycles through the repeat options (track, disc, etc.).
	Fast rewind.
	Fast forward.
	Press and release to skip back to the beginning of the current/previous track.
	Press and release to skip forwards to the beginning of the next track.
	Stop playback of a BD or DVD.
	Pause and playback of the current track.
	Start recording (on products that have this feature).
MENU	Disc menu.
POP UP	Activates BD/DVD player menu, if available.

	Navigate setup and BD/DVD programme selection menus. OK selects the highlighted file or enters the highlighted menu on the screen – equivalent to 'Enter' or 'Select' on some remote controls.  Up  Left  Right  Down BD +  Power on from Standby BD +  Standby from Power on BD +  changes the picture resolution (for BD, only on the Home screen).
	Returns navigation to the top level of the menu ('Home').
AUDIO	Changes audio decode format (Dolby Digital, DTS, etc.).
AMP	Resets remote to AMP mode.
RED	RED button for BD
GREEN	GREEN button for BD
YELLOW	YELLOW button for BD
BLUE	BLUE button for BD.

AV

AV Device Mode

The **AV** Device Mode button configures the remote to control the functions of a television or other display device. You will need to configure this Device Mode to work with your equipment. Pressing this button also selects **AV** as the source.

	Toggles power between standby and on. (Some TVs require you to use a number key to turn them on).
0...9	Functions as original remote number key – usually for channel selection.
DISP	Display INFO or OSD (On Screen Display) function, if available.
MODE	AV; this function is TV specific.
	Channel down.
	Channel up.
INFO	Displays picture information; this function is TV specific.
POP UP	Guide.
	Navigate setup and programme selection menus. OK confirms a selection (equivalent to 'Enter' or 'Select' on some remotes).
	Returns navigation to the top level of the menu ('Home').
AMP	Resets remote to AMP mode.
RED	RED key for Text TV
GREEN	GREEN key for Text TV
YELLOW	YELLOW key for Text TV
BLUE	BLUE key for Text TV.

UHD

UHD Device Mode

The **UHD** Device Mode button selects **UHD** as the source.











The UHD page allows code learning from a dedicated UHD remote – see "Customising the Remote" on page EN-22

STB

STB Device Mode

The **STB** Device Mode button selects **STB** as the source.

If configured to work with your set top box decoder or similar device, the remote can subsequently control the device.





	Toggles power between standby and on.
0...9	Functions as original remote number key – usually for channel selection.
DISP	Display INFO or OSD (On Screen Display) function, if available.
MODE	Selects the Library or Media function.
	Rewind.
	Fast Forward.
	Channel down.
	Channel up.
	Stop playback.
	Pause and playback of the current track.
	Record.
INFO	Opens the EPG (Electronic Program Guide) on some satellite and cable set top boxes.
POP UP	Turns on the Menu function if the set top box uses this feature.
	Navigate setup and programme selection menus. OK confirms a selection (equivalent to 'Enter' or 'Select' on some remotes).
	Returns navigation to the top level of the menu ('Home').
AUDIO	Selects the Help function.
AMP	Resets remote to AMP mode.
RED	RED button for set top box.
GREEN	GREEN button for set top box.
YELLOW	YELLOW button for set top box.
BLUE	BLUE button for set top box.

SAT

SAT Device Mode

The **SAT** Device Mode button selects **SAT** as the source.

If configured to work with your satellite receiver, the remote can subsequently control the device.









	Toggles power between standby and on.
0...9	Functions as original remote number key – usually for channel selection.
DISP	Display INFO or OSD (On Screen Display) function, if available.
	Channel down.
	Channel up.
INFO	Displays programme information.
POP UP	Guide (or Setup on some set top boxes).
	Navigate setup and programme selection menus. OK confirms a selection (equivalent to 'Enter' or 'Select' on some remotes).
	Returns navigation to the top level of the menu ('Home').
RTN	Back.
AMP	Resets remote to AMP mode.
RED	RED button for Satellite.
GREEN	GREEN button for Satellite.
YELLOW	YELLOW button for Satellite.
BLUE	BLUE button for Satellite.

PVR

PVR Device Mode

The **PVR** Device Mode button selects **PVR** as the source.

If configured to work with your personal (hard disc) video recorder or similar device, the remote can subsequently control the device.

	Toggles power between standby and on.
0...9	Functions as original remote number key – usually for channel selection.
INFO	Display INFO or OSD (On Screen Display) function, if available.
MODE	Selects the Library or Media function.
	Rewind.
	Fast Forward.
	Channel down.
	Channel up.
	Stop playback.
	Pause and playback of the current track.
	Record.
MENU	Opens the EPG (Electronic Program Guide) on some satellite and cable set top boxes.
POP UP	Turns on the Menu function if the PVR uses this feature.
	Navigate setup and programme selection menus. OK confirms a selection (equivalent to 'Enter' or 'Select' on some remotes).











	Returns navigation to the top level of the menu ('Home').
AUDIO	Selects the Help function.
AMP	Resets remote to AMP mode.
RED	RED button for PVR.
GREEN	GREEN button for PVR.
YELLOW	YELLOW button for PVR.
BLUE	BLUE button for PVR.







CD

CD Device Mode

The **CD** Device Mode button selects **CD** as the source.

The button is configured to control the CD functions of Arcam CD players, although this can be changed (see "Locking/Unlocking a specific Device Mode" on page EN-23).

	Toggles power between standby and on.
	Open/close disc tray.
0...9	Searches for and plays the track corresponding to the key pressed.
DISP	Cycles through the front panel display's brightness options.
MODE	Cycles through the repeat options (track, disc, etc.).
	Fast rewind.
	Fast forward.
	Press and release to skip back to the beginning of the current/previous track
	Press and release to skip forwards to the beginning of the next track.
	Stop playback of a CD
	Pause and playback of the current track.
POP UP	In 'normal play' (i.e. the display does not show the letter P), press the  and  keys to select the track and then MENU stores the track. In 'program play' mode, the MENU key deletes the stored track.

	Navigate setup and CD programme selection menus. OK selects the highlighted file or enters the highlighted menu on the screen – equivalent to 'Enter' or 'Select' on some remote controls.  Up  Left  Right  Down CD +  Power on from Standby CD +  Standby from Power on.
AMP	Resets remote to AMP mode.
RADIO	Plays the programmed tracks.

Essential Setup

Before you use your Receiver it is essential that you enter some information into the Setup menus about your speaker configuration. This allows the Receiver to process any surround sound digital source to exactly match your system and give you the ultimate surround sound experience.

There are three pieces of vital information which are outlined in the sections: 'Speaker Types', 'Speaker Distances' and 'Speaker Levels'.

The way you enter this information manually into the Receiver is given later in the 'Setup Menus' section on page EN-30.

When calibrated using Dirac Live room equalisation the speaker levels and delays will be established automatically and applied when the equalisation is turned on, speaker types however must be manually entered. For use with equalization turned off, the speaker size, speaker distance and speaker levels settings must be entered manually. It is important to understand why these speaker settings must be entered, which is why this section is presented before the section on equalisation.'

Speaker types

You need to set the type of speakers that you have connected to your Receiver:

Large	capable of full frequency range reproduction
Small	not capable of full frequency range reproduction at the low frequency end
None	speaker not present in your configuration

The terms 'Large' and 'Small' do not necessarily relate to the physical size of your speakers. As a rule of thumb, if a speaker cannot reproduce a flat frequency response down to about 40Hz (and very few can!) it is often better to consider them as 'Small' for setup purposes of home cinema.

When a speaker is set to 'Small', very low frequency sounds are redirected away from that speaker to a 'Large' speaker or a subwoofer, which are far better suited to reproducing these low frequency sounds.

Note that it is not possible to set all speakers to 'Small' unless there is a subwoofer in your speaker configuration. If you do not have a subwoofer, you will be forced to set your front speakers to 'Large'.

(Advanced users may wish to automatically override the 'Small' speaker setting for purely stereo music listening when not watching movies. This can be achieved in the 'Input Config.' menu – see page EN-31.

Crossover frequency

If you have set any speakers as being Small, then you will be required to set a value for the crossover frequency. This is the frequency below which signals are filtered away from these Small speakers and redirected to Large speakers or the subwoofer (if present). A frequency of 80Hz is often a good starting point, however you will probably have to experiment with different values to find the best value for your system or consult your speaker handbook.

Use Channels 6+7 for

If not used in the main zone, it is possible to assign the Surround Back channels to Height 1, bi-amp the Front Left/Right channels or to provide an amplified output to Zone 2.

Speaker Levels

Finally the levels of all the speakers in the system need to be adjusted to match each other at the listening position, again to create a proper surround effect. To help with this the Receiver can generate a test noise for each speaker which should be measured with a sound pressure level (SPL) meter. The meter should be set to 'C' weighting and slow response. Several smartphone/tablet apps are available which can also perform this function. The level of noise measured at the listening position from each speaker should be adjusted on the Speaker Trims page of the Setup menu so that the meter reads 75dB SPL. It does not matter what the system volume setting of the Receiver is before turning the test noise on as the volume setting is over-ridden for the duration of the speaker noise test.

There are several basic SPL meters on the market at reasonable prices aimed at home cinema enthusiasts. Check your local technology store, search online or ask your dealer.

If you do not have an SPL meter or suitable app, you can try to adjust the noise level of each speaker by ear. In this case it is not possible to adjust the speakers to the absolute 75dB SPL volume level, but you should aim for all speakers sounding equally loud. Setting speaker test noise levels by ear is not recommended as it is very difficult to do accurately, but is often better than doing nothing at all!

Speaker Distances

It is essential for the distance from each speaker to the listening position to be accurately measured and entered into the 'Setup' menu. This ensures that the sounds from the various speakers arrive at the listening position at the correct time to recreate a realistic surround effect. The distance can be entered in centimetres or inches.

Auto Speaker Setup



Dirac Live for Arcam

There is a proprietary automatic loudspeaker calibration function built into your Receiver from Dirac Research. Using a PC/MAC based application, this attempts to set the essential speaker settings for all the speakers in your system. It also calculates room equalisation (Room EQ) filter values to remove some of the worst effects of resonant frequencies in the listening room.

Your Receiver package is supplied with a calibration microphone, which should be inserted into a USB socket on a PC or MAC connected to the same network as the Receiver and positioned as directed by the Dirac Live PC/MAC application. This microphone picks up the special calibration tones generated by the speakers when Dirac Live application is run. The Receiver then analyses the signal and computes:

- speaker delays,
- speaker level,
- problem resonant frequencies in the room which need control by filtering.

To help the system be as accurate as possible when performing Dirac Live setup, there are a few guidance rules that should be followed:

- Minimise any background sounds in the listening room and other nearby rooms.
- Close all windows and doors in the listening room.
- Turn off all fans including air-conditioning systems.
- Mounting the microphone on a tripod or similar.

- Position the set up microphone pointing upwards at roughly head height when sat in the normal listening position. It is not necessary to point the microphone directly at the speaker generating the test tone, the microphone should be pointing vertically towards the ceiling. (It helps if you are able to position the microphone exactly where your head would normally be for listening, with the microphone in direct unobstructed view of all speakers.)

- If your system includes an active subwoofer, start by setting its output level/gain control to a value roughly matching the front speakers.

When activated, a calibration tone is played through each channel of the Receiver in turn, including the subwoofer channel. The calibration tone cycles round each of the speakers multiple times as the different parameters are calculated. Follow the 'progress' information on your PC/MAC.

By default, Room EQ is not applied to any of the source inputs. You should enable Room EQ on inputs you think benefit from this feature, as required, by listening when playing typical source material through each input. After being calculated, this is enabled from within the Input Config menu.

While room equalisation can help to reduce problems with listening room acoustics, it is usually far better to try to solve these problems with the room directly. Proper loudspeaker positioning, acoustic wall treatments and moving the listening position away from walls should produce far better results overall. However it may be difficult to do this in a home environment, so Room EQ is your next best choice.

Problems

We advise you to look over the reported measurements on the screen following Dirac Live setup for any obviously incorrect results, in particular to ensure the reported speakers match your configuration and that the speaker distances to the listening position appear look roughly correct. If the results are not what you expected re-run Dirac Live setup.

The Dirac Live setup function is normally quite accurate but occasionally false results can be generated. Problems may be as a result of:

- external sounds or rumbling/handling noises picked up by the microphone
- sound reflections off hard surfaces (e.g. windows or walls) close to the listening position,
- very strong acoustic resonances within the room,
- obstacles (such as a sofa) between speakers and the microphone.

If you are still experiencing difficulties or you wish to have the most accurate results for ultimate surround performance, we recommend using the manual method of establishing speaker distances and levels.

Using subwoofers

If your system includes active subwoofers you may need to set the subwoofer output level/gain control set to a higher or lower value.

Please refer to the Dirac application and quick start guide for full details of how to use the system with your Receiver.

Downloading the Dirac Live application

To download the Dirac Live PC/MAC application and quick start guide, please visit:

live.dirac.com

Using Dirac

You can store up to three Dirac EQ curves in the Receiver. Each input can use a different curve, for example a "Movie" curve on the BD input and "Music" curve on the CD input.

This can be set on a per input basis using the **AUDIO** key on the remote.

Alternatively use the Room EQ menu item in the Audio settings menu to set the curve for each input. See "Room EQ" on page EN-31.

Note: When Dirac is run for the first time the curve will be applied to all inputs. Subsequent curves will not be automatically applied, use the methods above to choose the required curve for the input in question.

For AVR5 an additional license and calibration mic are required, please visit:

live.dirac.com

Setup Menus

The Setup menus allow you to configure all aspects of your Receiver. The next few pages will go through the menu items and explain their function. The Setup menus will probably look quite daunting if you are new to setting up home cinema, but the majority of them need only be configured once when you first install the system (or if your system changes or you move house!)

Entering Setup mode

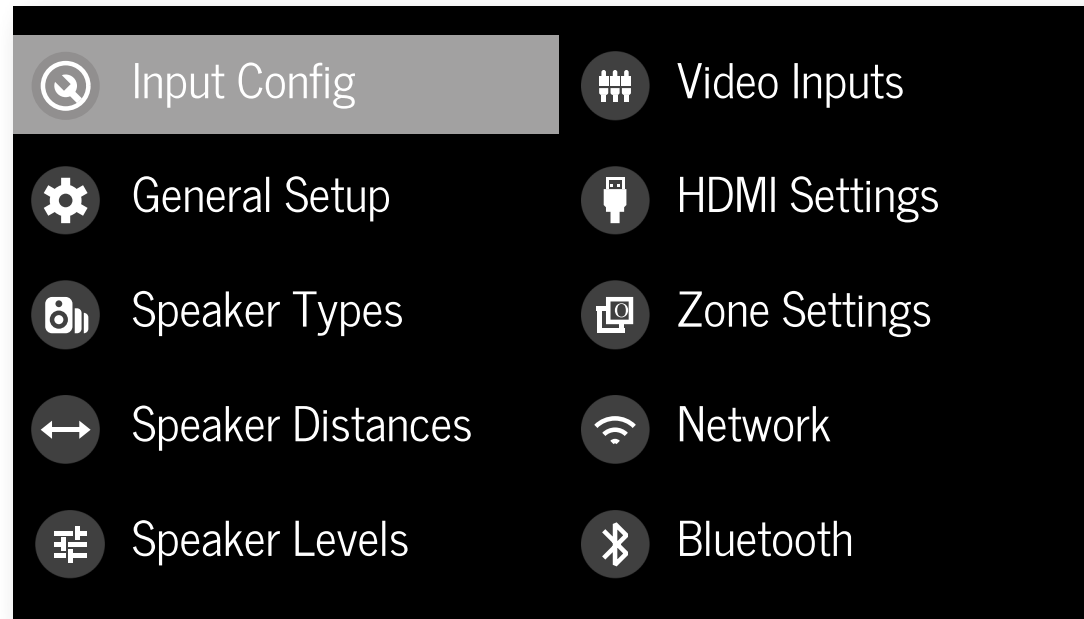

To enter the setup menu, press the **MENU** button on the remote control or front panel. The front panel display shows the setup menu (pictured right).





Navigating the setup menu

... using the remote control

The setup menu can be navigated by using the cursor (arrow) keys on the remote control. This is by far the easiest method.

1. To enter the setup menu, press the **MENU** button (which is located immediately under the navigation buttons).
2. Use the  and  keys to navigate up and down the main section headings.
3. Once you have the main section that you require highlighted, use the  key to enter the section.

4. Use the  and  keys to navigate up and down the section settings in the right-hand panel. Some settings may be greyed out. These are either for information only (e.g. incoming sampling frequency) or are not currently selectable. Scroll bars on the sides of the right hand panel indicate your position in the settings list where there are more items than can be displayed at once.
5. Pressing **OK** selects a setting to change it, pressing **OK** again de-selects the setting.
6. At any time, press the **MENU** button to exit the menu. Any changes to settings are saved.

... using the keys on the front panel

The Receiver front panel controls can be used to configure the unit. Follow the instructions for using the remote control, in this case using **INPUT-** for down, **INPUT+** for up, **INFO** for left and **MODE** for right.

Input Config.

The audio and video settings on this page of the Setup menu can be tailored **specifically and independently for the currently selected input**.

When a different input is selected on the Input line, all the input-specific settings for that input are displayed below it. These settings are applied to the named Input only and are stored in memory and recalled each time the unit is powered up and whenever that input is selected.

Input – The currently selected input connectors to which the settings below relate.

Name – The display name of the input. You can change the name of any input to more closely match your setup. For example, if you had two satellite receivers, you could connect the main receiver to the Sat audio and video input connectors and change the Name to 'SAT 1'. You could then connect the second satellite receiver to the UHD audio and video input connectors, but change the UHD Name to 'SAT 2'. It is then clearer to users of your Receiver which inputs they wish to select when scrolling through.

Lip Sync – Each input can have its own setting to add a time delay between the audio and video signals to compensate for the sound and picture not being synchronised. This is normally required when video processing is used in the system for scaling or de-interlacing video. The range of lip sync delay is 0 to 250 milliseconds.

The lip sync adjustment can only correct for delayed video. If the audio is late set lip sync to its minimum.

Mode – Sets the initial audio decode mode for stereo sources on this input.

- Last Mode recalls the last used setting for this input when a stereo source was applied. See section "Two-channel source modes" on page EN-35 for more information.

MCH. Mode – Sets the initial audio decode mode for multi-channel digital sources on this input.

- Last Mode recalls the last used setting for this input when a stereo source was applied. See section "Multi-channel source modes" on page EN-35 for more information.

Bass –

Treble –

These allow you to alter the bass and treble tone controls for all currently active speakers for each individual input. For example, if your PVR source sounds a little bass light, you can always correct for this by selecting PVR on the Input line at the top of this menu and add 2 or 3dB to the Bass control. Then, whenever the PVR input is selected, the bass is automatically boosted for as long as that input is selected.

Room EQ – When the Dirac Live application is run and EQ filters are downloaded into one of the three slots available, this can be selected.

- Not Calculated:** (Information only) There are no EQ filters, so cannot be selected.
- Project Name:** Dirac Live Room EQ is applied to the current source and will display the name of the project from the Dirac Live application.
- Off:** Dirac Live Room EQ is not applied to the current source.

Input Trim – Sets the maximum analogue input signal level (sensitivity) on this input before the ADC (Analogue-to-Digital converter) signal path clips. Options are 1, 2 and 4 volts RMS maximum input. The default is 2Vrms maximum.

For example, analogue sources with low output levels may benefit by choosing the 1V maximum setting. This helps maximise signal-to-noise performance of the Receiver and also helps keep the various analogue sources sounding about the same level for any given Receiver volume control setting.

Dolby Audio Processing – Applies Dolby Audio Processing to the incoming audio.

- Off:** (default) Dolby Audio Processing is not applied to this input.
- Movie:** Suitable for movie viewing.

- Music:** Suitable for music listening.

- Night:** Compresses the audio to be more suitable for late night viewing or listening.

Stereo Mode – If you have configured your system to have a subwoofer, then you have the flexibility to choose how bass information is distributed between the front left/right speakers and the subwoofer when listening to stereo (two channel only) analogue and digital sources. Choose the option which gives you the most solid, even sounding bass. If you are using a subwoofer for stereo, please also see Sub Stereo below to set the level of the subwoofer. For best results test with a setup disc or live programme material. This setting can be used to override your normal speaker settings in the Spkr Types menu whenever the Receiver plays stereo material. It is quite common to find that two channel stereo music listening is best done with a slightly different sub/speaker setting than for surround movies.

- As Spkr Types:** When an analogue or digital stereo source is played, your normal speaker configuration (as in **Spkr Types** menu) is used to reproduce the signal.
- Left/Right:** Full frequency stereo information. All audio is sent to the front left and right speakers only without any bass redirection. You can use this setting if you consider your front left/right speakers to be able to handle the full frequency range of music. If you have set your front left/right speaker size as Small in the Spkr Types setup page, you may wish to use this option to override the setting to Large for stereo music listening, if you have full frequency range left/right speakers. It can often be beneficial to set full frequency range speakers to Small in the Spkr Types setup page for use with movies, if you have a subwoofer in your system. Doing so may deliver more impact on movie soundtracks as subwoofers are designed to handle reproduction of high bass content. However you may find that for stereo music a better overall result is obtained by not using the subwoofer and effectively treating the front left/right speakers as Large.

- Left/Right+Sub:** Full frequency range stereo is fed to the front left and right speakers and extracted bass is sent to the subwoofer. In this case the low frequency information is effectively duplicated.

- Sat+Sub:** Use this setting if you really do have Small satellite front left and right speakers, or if you prefer the overall sound of bass being handled by the subwoofer. Full bass management is used so that analogue and digital stereo sources are fed to the DSP where the bass is filtered off front left and right and redirected to the subwoofer.

NOTE: The Stereo Mode function is not available when using an analogue source in Stereo Direct mode.

Sub Stereo – If Left/Right+Sub or Sat+Sub is selected in Stereo Mode above, this setting adjusts the level of the subwoofer when the source is two channel stereo.

IMAX mode (AVR11, AVR21, AVR31, AV41) – Selects if IMAX mode is enabled from the incoming audio stream (auto) or forced on or off.

Auro-matic 3D (AVR11, AVR21, AVR31, AV41) – Selects the mode of the Auro-matic 3D upmixer.

- Small:** Adjusts the upmixer for a small-sized room.
- Medium:** (default) Adjusts the upmixer for a medium-sized room
- Large:** Adjusts the upmixer for a large-sized room.
- Movie:** Adjusts the upmixer for film material.
- Speech:** Adjusts the upmixer to focus on speech intelligibility.

Auro-matic 3D Strength (AVR11, AVR21, AVR31, AV41)

– Adjusts the amount of unprocessed to processed signal when using the Auro-Matic 3D upmixer.

Audio Source – Selects the particular connection type for each input. The default is HDMI for inputs with an HDMI connection and Digital for inputs without an HDMI connection. This setting must be changed if another connection is used.

Select from the list the audio type you are using on this

source.

- HDMI:** the unit is forced to use the HDMI audio input for this source.
- Digital:** the unit is forced to use the optical (**TOSLINK**) or coaxial (**S/PDIF**) digital audio input for this source
- Analogue:** the unit is forced to use the analogue audio input for this source.

CD Direct – Turns on/off the compressed audio detection mute delay. Your AVR mutes when it detects a change or break in a digital stream. This is intentional and prevents unwanted noise from being output from your speakers when using sources that change between multiple formats (e.g. a Blu-ray player or TV Set Top Box). CD direct can be activated when used with a source that will only transmit a consistent format (e.g. a CD player with PCM audio). This will defeat the muting and prevent potential loss of the beginning of tracks where audio begins very promptly.

General Setup

General information and system controls.

Source Input – (Information only) The currently selected input to which the settings below relate.

Incoming Format – (Information only) The format of the digital audio stream connected to this input, if present.

Incoming Sample Rate – (Information only) The sample rate of the digital audio stream connected to this input, if present.

Incoming Bit Rate – (Information only) The bit rate of the digital audio stream connected to this input, if present.

Dialnorm – (Information only) If a Dolby Digital audio stream is connected to this input, this is the Dialogue Normalisation setting requested by the stream.

Incoming Resolution – (Information only) Shows the incoming video resolution.

Audio Compression – Allows selection of compression which is ideal for late night listening. The compression effect increases the volume of the quiet passages and decreases the volume of the louder passages. Compression only applies to Dolby/DTS soundtrack formats that support this function.

- Off:** (default) no audio compression is applied.
- Medium:** compression is applied so that loud portions of a soundtrack are reduced in level. Dolby

True HD stream is compressed automatically as set by the incoming stream.

- High:** the maximum amount of dynamic range compression is applied, so that the difference between loud and quiet portions of a soundtrack is minimised.

This setting applies to all inputs when a relevant digital audio stream is detected. It is stored in memory and recalled each time the unit is powered up.

Balance – To alter the sound balance temporarily between front left and right speakers. You can alter the sound stage to either the left or the right by up to 6dB. Note that it is not possible to shift the audio signal completely over to one channel. This function resets to equal left/right balance when the input is changed.

DTS Dialogue Control – Sets the level of the dialogue channel in compatible DTS audio streams.

Maximum Volume – Limits the maximum volume setting the system can be turned up to in the main zone. This is a useful feature to prevent accidental overdriving of low power-handling speakers (for example). It is stored in memory and recalled each time the unit is powered up.

Max On Volume – Limits the maximum volume the system operates in the main zone when it is switched on or comes out of Standby. The system comes on at this stored volume setting if the last used (possibly very loud) volume exceeds this value. It is stored in memory and recalled each time the unit is powered up.

Display on time – Sets the time that the front panel display remains illuminated after receiving a command. The default is always on.

Control – Enables or disables RS232 or IP (NET) control, a system that allows control from various third-party home automation systems. Note, only RS232 or IP control can be used, not both.

Power on – Determines how the unit powers on.

- Stby:** in Standby mode
- On:** On
- Last state:** Last state (default).

Language – Select the language for the setup menu – English, French, German, Spanish, Dutch, Russian, Chinese.

Speaker Types

Settings for the types of loudspeaker you have connected in your configuration. These settings are applied to all audio inputs and are stored in memory and recalled each time the unit is powered up.

Front Left/Right –

Centre –

Surr. Left/Right –

Surr. Back L/R –

Height Front –

Height Back –

Here you set the type of speakers that you have connected to your Receiver:

- Large:** capable of full frequency range reproduction
- Small:** not capable of full frequency range reproduction at the low frequency end
- None:** speaker not present in your configuration

NOTE: It is not possible to set all speakers to Small unless there is a subwoofer in your speaker configuration. If you do not have a subwoofer, you will be forced to set your front speakers to Large.

NOTE: If there are only two ceiling height speakers connected, these need to be set as front, though can be placed either in front of, or above, the listening position.

Subwoofer – configures if the dedicated sub out terminals are used for a single subwoofer channel (using the two parallel outputs).

Channel 13 & 14 –

Channel 15 & 16 –

Configures the speaker positions that channels 13, 14, 15 & 16 are used for.

Height Type – configures the type of height speakers – ceiling mounted or Dolby enabled.

Use Channels 6+7 for – If your main zone speaker set up does not include Surround Back Left and Right speakers, you can choose to use the Surround Back amplifier channels as

the Height 1 amplifiers, to Bi-Amp the Front Left and Right pair, or as a stereo power amplifier for Zone 2.

Filter Slope – Configures the filter slope used for bass management – 12dB, 24dB, 36dB, 48dB/octave.

Sub Gain – configures the output level trim for all outputs configured as subwoofers in -6dB steps from 0dB to -30dB.

Speaker Distances

Calibration settings for the distances between the loudspeakers and the listening position.

NOTE: Speakers that are not present in your configuration will be greyed out.

If Dirac Live is used, these settings will be shown in time (ms) and not distance.

These settings are applied to all audio inputs and are stored in memory and recalled each time the unit is powered up.

Units – Select whether you wish to measure distances in imperial or metric units.

Front Left –

Centre –

Front Right –

Surr. Right –

Surr. Back Right –

Surr. Back Left –

Surr. Left –

Left Top Front –

Right Top Front –

Left Top Back –

Right Top Back –

Subwoofer –

Channel 13 –

Channel 14 –

Channel 15 –

Channel 16 –

As described in "Essential Setup" on page EN-28, measure the distance from each loudspeaker in your system to your ear in the main listening position and enter the values. This allows the Receiver to calculate the correct relative delay for each

loudspeaker.

Speaker Levels

Calibration settings for the test noise signal level through the loudspeakers and measured at the listening position.

NOTE: Speakers that are not present in your configuration will be greyed out.

These settings are applied to all audio inputs and are stored in memory and recalled each time the unit is powered up.

Test Tone – selects the internal test tone generator or allows the use of an external test tone from the currently selected HDMI input (e.g. played from a BD).

Front Left –

Centre –

Front Right –

Surr. Right –

Surr. Back Right –

Surr. Back Left –

Surr. Left –

Left Top Front –

Right Top Front –

Left Top Back –

Right Top Back –





Subwoofer –

Channel 13 –

Channel 14 –

Channel 15 –

Channel 16 –

Use the  and  navigation buttons on the remote control to select the relevant speaker. Press  to enable/disable the calibration noise and the  and  navigation buttons to adjust the noise level from each speaker.

As described in “Essential Setup” on page EN-28, adjust the

level of the test noise from each speaker so that an SPL meter at the listening position measures 75dB SPL.

Video Inputs

Settings to optionally assign a video source to each of the normally audio-only inputs.

These settings are stored in memory and recalled each time the unit is powered up.

Video Input CD –

Video Input Aux –

Video Input FM –

Video Input DAB –

Video Input Net –

Video Input BT –

The default for each of the audio inputs is ‘None’. You could, however, associate ‘Sat’ video with FM or Digital Radio audio to receive radio commentary of a sports game with pictures from satellite coverage, for example.

HDMI Settings

The settings in this menu control the output resolution from the video processor in the Receiver. These settings are applied to all video inputs and are stored in memory and recalled each time the unit is powered up.

Zone 1 OSD – Selects whether the main zone pop-up OSD messages are On or Off. It is stored in memory and recalled each time the unit is powered up.

- When **On**, all user adjustments that are made during the general use of the Receiver are displayed on screen as well as the front panel display. This includes the adjustment of volume, subwoofer level, lip sync, tone controls, etc. It is stored in memory and recalled each time the unit is powered up.
- When **Off**, the above user adjustments will not appear on screen, only on the front panel display. This leaves the picture on your display device clear of pop-up text. However, regardless of this setting the Setup menus are always displayed on screen.

Zone 1 Out – This setting controls the output for zone 1 from either output1, output2 or both.

Zone 1 Lipsync – (Information only) Displays how much lip sync is automatically applied to the HDMI output to

compensate for video processing delays in the attached display device. Not all display devices support this function.

HDMI Audio to TV – This setting controls the audio being sent direct to the TV.

HDMI Bypass & IP – This setting controls the functionality of HDMI bypass & IP control while in standby. Selecting “Low Power” (default) will mean that IP control (network) and HDMI bypass are disabled. Selecting “HDMI & IP On” means that IP Control (network) & HDMI bypass is enabled.

HDMI Bypass Source – Selects which input is used for HDMI bypass function, either a specific input or the last input used.

CEC Control – Selects if CEC control is enabled on output 1.

eARC Control – This setting enables/disables volume control from the display.

TV Audio – This setting enables/disables auto-switching to eARC audio from the display.

Power Off Control – This setting enables/disables auto-power control from other CEC-enable devices.

Zone Settings (AVR21, AVR31, AV41)

Lists the volume and control settings for Zone 2. These settings are applied to all audio inputs and are stored in memory and recalled each time the unit is powered up.

Z2 Input – Selects the input to be routed to Zone 2. The default is ‘Follow Z1’, i.e. the same source as currently selected in Zone 1.

Zone 2 Status – Selects if Zone 2 is in Standby or On.

Zone 2 Volume – The current volume in Zone 2.

Zone 2 Max. Vol – Limits the maximum volume setting the system can be turned up to in the Zone 2. This is a useful feature to prevent accidental overdriving of low power-handling speakers, for example.

Zone 2 Fixed Vol – The Zone 2 volume control can be locked at the current value for use with an external amplifier with its own volume control in Zone 2.

Zone 2 Max On Vol – Limits the maximum volume the system operates in the Zone 2 when it is switched on or comes out of Standby. The system comes on at this volume if the last used (possibly very loud) volume exceeds this value.

Connecting to a Network

Network

The Receiver is fitted with a network audio client which is capable of AirPlay 2 and Chromecast built-in as well as stored music on a network storage device such as a PC, or on NAS drive.

The wireless network is configured using the Apple AirPlay setup or the Google Home app.

SSID – (Information only) Displays the SSID the receiver is currently connected to, “wired” if a wired connection is used, or “not connected” if no connection is present.

IP Address – (Information only) IP address assigned by the DHCP server, or if not using DHCP, the IP address you have assigned to the Receiver for your network.

MAC address – (Information only) The unique address of the network card in your Receiver.

Friendly name – (Information only) The network “friendly name” of your Receiver.

Bluetooth

The Receiver is fitted with a Bluetooth audio input.

Pair Device – Makes the Receiver discoverable by Bluetooth devices.

Clear Paired Device List – Clears the Receiver’s list of paired Bluetooth devices..

Paired Devices – Displays a list of the devices paired with the Receiver.

In order to use the AirPlay and Chromecast built-in functionality of the Receiver you will need to connect it to your home network via a wireless or wired connection.

The following sections detail how to do this.

Note: Before attempting to setup a wireless connection ensure the supplied wireless antennas are fitted to the antenna socket on the rear of the Receiver.

Home Automation Control

When connected to a network the Receiver can be controlled and monitored remotely using dedicated home automation software.

The same controls are also available via the RS232 input.

Various third-party systems are available providing sophisticated control over all your entertainment devices. Contact your dealer or installer for details. The technical details of the remote control protocol are available upon request, by contacting Arcam at luxurysupport@harman.com.

For details of the available controls please refer to the control document which can be found at www.arcam.co.uk for further information.

AirPlay Setup

Wired Connection

Connect an ethernet cable to the Receiver.

To listen to audio via AirPlay on your Receiver, ensure your Apple device is connected to the same network as the Receiver and simply select the Receiver as the AirPlay audio playback device.

Note: The Receiver will appear as ARCAM modelName-xxxxxx in the AirPlay speaker menu, where xxxxxx is the last 6 digits of the units MAC address.

Wireless Connection

Ensure your Apple device is connected to the wireless network you wish to connect the Receiver to.

Open the Wi-Fi settings menu on the Apple device and select the Receiver from the “Set up new AirPlay speaker” menu.

Follow the instructions on screen. To listen to audio via AirPlay on your Receiver, ensure your Apple device is connected to the same network as the Receiver and simply select the Receiver as the AirPlay audio playback device.

Note: The Receiver will appear as ARCAM modelName-xxxxxx in the AirPlay speaker setup menu, where xxxxxx is the last 6 digits of the units MAC address.

Chromecast built-in Setup

Wired Connection

Connect an ethernet cable to the Receiver.

Wired & Wireless Connection

Download and open the Google Home application.

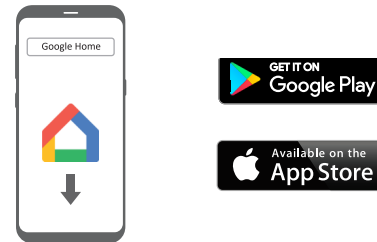

You should be prompted that there is a device available for setup. If not simply tap “Add” followed by “Setup a Device”. Select the Receiver and follow the instructions on screen.

To listen to cast audio from any supported application on your Receiver, ensure your device is connected to the same network as the Receiver. Tap the Chromecast built-in icon from within the application and select the Receiver as the playback device.

Note: The Receiver will appear as modelName-xxxxxx in the setup menu, where xxxxxx is the last 6 digits of the units MAC address.

Spotify Connect

Use your phone, tablet or computer as a remote control for Spotify.

Go to spotify.com/connect to learn how.

Decoding Modes

Introduction

Your Receiver provides all the key decoding and processing modes for analogue and digital signals, including the latest high definition audio formats over HDMI.

Modes for digital sources

Digital recordings are usually encoded to include information about their format type. The Receiver detects automatically the relevant format in a digital signal – such as Dolby Atmos, TrueHD, Dolby Digital Plus, DTS:X, DTS-HD Master Audio, Auro 3D, Dolby Digital, or DTS – and switches in the appropriate decoding.

Modes for analogue sources

Analogue recordings do not contain information about their encoding formats, so the desired mode – such as Dolby Surround – needs to be selected manually.

Mode memory

Dolby Digital or DTS audio (including the high definition formats) can be output in two mix modes, selected using the **MODE** button:

- Surround (e.g., five main channels plus a subwoofer for a 5.1 source)
- Stereo downmix.

Two-channel audio, regardless of whether it is analogue or digital can also be output in two mix modes, selected using the mode button:

- Surround (e.g., Dolby Surround, DTS Neural:X, etc.)
- Stereo.

The Receiver stores the settings for each source. Thus the decoding mode for the following groups of source material can be stored independently:

- Dolby Digital (multi-channel) and DTS source material
- Two channel Dolby, PCM or Analogue source material

Two-channel source modes

The following decoding and surround modes are for creating multi-channel stereo modes from 2-channel sources. They are available on the Receiver for standard and high definition Dolby Digital 2.0, DTS 2.0, PCM or analogue sources:

Stereo –

16 Channel Stereo –

Dolby Surround –

Dolby Virtual Height -

DTS Neural:X -

DTS Virtual:X -

Auro-matic 3D (AVR11, AVR21, AVR31, AV41)

Stereo

In this mode the Receiver works as a conventional high quality audio amplifier. Note that if the subwoofer is enabled in stereo mode, then some processing of the signal is carried out.

- Stereo Direct:** this achieves the most direct signal path if an analogue connection is present.
- 16 Channel Stereo:** this produces an output from all speakers by copying the left output to all left speakers and the right output to all right speakers. The centre speaker outputs a mix of left and right.

Dolby Surround

Dolby Surround allows the Receiver to derive up to 16 outputs from a two or multi-channel source to take better advantage of all amplifiers and speakers in your setup.

Dolby Virtual Height

Dolby Virtual Height creates an immersive audio experience by virtualising height content over traditional speaker configurations without the need for height speakers. Note - this mode is NOT available if height speakers are selected.

DTS Neural:X

DTS Neural:X is an advanced up-mixer that renders up to 7.1.4 channels of immersive audio from nearly any lower channel count content.

DTS Virtual:X

DTS Virtual:X creates an immersive audio experience by virtualising height content over traditional speaker configurations without the need for height speakers. Note - this mode is NOT available if height speakers are selected.

Auro-matic 3D (AVR11, AVR21, AVR31, AV41)

Auro-matic 3D creates an immersive audio experience by creating additional channels from the incoming audio to match the available output channels, enhancing the listening experience.

Multi-channel source modes

Digital multi-channel source material is normally provided as '5.1 audio'. The '5.1 channels' comprise of: left, centre and right front speakers, two surround speakers and a low frequency effects (LFE) channel. Since the LFE channel is not a full range channel, it is referred to as '1'.

Surround systems decode and reproduce the 5.1 channels directly. The DTS-ES matrix enhanced decoding system creates one extra rear channel from information buried in the two surround signals of the 5.1 source. The ES enhanced system is sometimes referred to as a '6.1' system. This extra surround back channel is normally reproduced through two separate loudspeakers, creating a '7.1' system.

DTS-ES discrete is a true '6.1' source, with six discretely encoded channels, plus the '1' LFE channel.

Dolby Digital Plus, Dolby TrueHD, Dolby Atmos, DTS:X, DTS-HD, Auro 3D are high-resolution surround formats found on Blu-Ray discs

Decoding modes

The modes given in the following table are available for multi-channel digital sources.

Special modes such as DTS-ES 6.1 discrete, Dolby Digital Plus, Dolby TrueHD, Dolby Atmos, DTS:X, DTS-HD and IMAX® ENHANCED, Auro 3D are only available from the correct source material.

High resolution audio sources	
Dolby Atmos	Dolby Atmos content is mixed as audio objects instead of traditional channels, so can take full advantage of the number and placement of your speakers.
Dolby TrueHD	Provides up to 7.1 full channels at 96kHz, 24bit resolution, with potentially no losses in the compression process. Data rates can be up to 18Mbps.
Dolby Digital Plus	Provides up to 7.1 discrete channels of audio with less compression than traditional Dolby Digital encoding. Data rates can be up to 6Mbps.
DTS-HD Master Audio	Provides up to 7.1 full channels at 96kHz, 24bit resolution, with potentially no losses in the compression process. Data rates can be up to 24.5Mbps.
DTS:X®	<p>DTS:X is a decoder package that renders immersive content which has been encoded with DTS:X encoding. DTS:X content consists of audio objects or a combination of audio channels and objects. The DTS:X decoder package also plays back legacy DTS formats including DTS-HD Master Audio lossless and lossy streams.</p> <p>Supports greater than 7.1 channel output configurations (including height speakers)</p> <p>Provides "Dialogue Control" so consumers can adjust the sound to their preference or the listening environment</p> <p>Remaps any DTS content to any speaker layout</p> <p>Supports Blu-ray Disc (BD), DVD and streaming media formats, and legacy streams up to 192kHz.</p> <p>Includes Neural:X, the latest upmixing/downmixing technology from DTS.</p>
IMAX ENHANCED (AVR11, AVR21, AVR31, AV41)	IMAX® Enhanced products meet the highest level of standards, ensuring the best color, contrast, clarity and sound on the market. These are products endorsed by IMAX to fully deliver the most immersive at-home entertainment experience and leverage the full quality and scale of IMAX Enhanced content. The IMAX Enhanced program introduces a new standard in home entertainment.
AURO 3D (AVR11, AVR21, AVR31, AV41)	AURO 3D is a decoder package that renders the audio at three levels - ear level, height level and the centre height level, creating an immersive sphere of audio.

For Dolby Digital sources	
Dolby Digital 5.1	Dolby Digital 5.1 sources deliver sound with five discrete full-range channels; left, centre, right, surround left, surround right, plus LFE channel.
Dolby Digital Stereo Downmix	Provides a stereo downmix of the source material for use with headphones.
Dolby Digital 5.1 + Dolby Surround	This mode is used to derive information for the individual surround back channels from the surround channels, using the Dolby Surround decoder.
For DTS sources	
DTS 5.1	Less common than the Dolby Digital format, but generally recognised within the audio industry as being of superior sound quality. DTS 5.1 delivers surround sound with five full range channels plus an LFE channel.
DTS 5.1 Stereo Downmix	Provides a stereo downmix of the source material for use with headphones.
DTS-ES 6.1 Matrix	This is a 6.1 channel format based on DTS 5.1. It has the sixth channel matrix encoded into the surround left and surround right channels. The sixth channel is a surround centre channel and is directed to the surround back left and surround back right speakers.
DTS-ES 6.1 Discrete	This is a true discrete 6.1 channel sound format. DTS-ES discrete mode operates only on sources with DTS-ES 6.1 discrete audio encoding.
DTS96/24	Provides up to 5.1 channels of audio at 96kHz, 24bit resolution for superior sound quality compared to standard DTS 5.1

Tuner Operation

The Receiver is fitted with an FM/DAB/DAB+ (digital radio) tuner. DAB broadcasts are not available in all locations.

This section deals with tuner operation, for information on setting up the tuner and installing aerials, see page EN-13.



The front panel will also give the same information, pressing the **INFO** key will cycle through the various items of information:

FM
<input type="checkbox"/> Processing mode (default)
<input type="checkbox"/> Radiotext (if available)
<input type="checkbox"/> Programme type (if available)
<input type="checkbox"/> Signal strength
DAB
<input type="checkbox"/> Processing mode (default)
<input type="checkbox"/> Radiotext (if available)
<input type="checkbox"/> Programme type
<input type="checkbox"/> Signal quality
<input type="checkbox"/> Bit-rate of transmission

Tuning/Channel Selection

When switching to the internal **TUNER** source, the Receiver enters the last used tuner band, be it FM or DAB. Repeatedly pressing **RADIO** cycles through the available tuner bands on your Receiver.

FM analogue radio

Frequency tuning on FM radio is performed using the  and  buttons on the remote control in **TUN** device mode. Individual presses move the frequency down and up one step. If you press and hold either of the tuning buttons for two seconds, the tuner scans to the next strong signal. You can stop a scan at any time by pressing one of the tuning buttons again.





In Europe, the internal FM radio is capable of receiving RDS (Radio Data System) radiotext signals that are transmitted on some stations. The RDS information typically includes the radio station name, the music or speech genre as well as additional information related to the current programme. On music stations this is often information on the currently playing track.

DAB digital radio



Digital Audio Broadcasting (DAB) radio is becoming more widely available. See www.worlddab.org/country_information for information on DAB availability.

You will need to scan for available stations before being able to listen to them.



To scan for DAB stations, first select the DAB tuner then press and hold  until the display indicates scanning has started. The Receiver will then scan all the DAB radio frequencies and compile a list of the stations that are available.

When the scan is complete, you can scroll through the station list using the  and  buttons on the remote control. To listen to the currently displayed station press the . If you do not press  within two seconds, the display will revert to displaying the currently playing station.

Saving and selecting Presets

Preset selection uses the  and  keys on the remote to browse and  to select the preset when the remote is in **TUN** device mode.

Up to 50 presets can be stored and these can be from any

band, for example Preset 1 could be an FM station, preset two a DAB station, etc. Pressing the **OK** key causes the next available preset number to be displayed, then pressing the **OK** key again stores the current frequency/channel in that preset. If a different preset number is required, press the  and  keys until the desired number is displayed before pressing the **OK** key for a second time.

Deleting Presets

When in tuner browse mode (using  and  to scroll through the presets), the yellow button on the remote is used to delete the currently highlighted (but not playing) station or frequency.

Troubleshooting

Problem	Check the following
There are no lights on the unit	<ul style="list-style-type: none"> <input type="checkbox"/> The power cord is plugged into the receiver and the mains socket it is plugged into is switched on. <input type="checkbox"/> The power button is pressed in. <input type="checkbox"/> If a red led is present, the receiver is in standby mode. Press any button on the front panel or the standby button on the remote control.
The unit responds erratically or not at all to the remote control	<ul style="list-style-type: none"> <input type="checkbox"/> There are fresh batteries in the remote control. <input type="checkbox"/> The front panel window is visible and you are pointing the remote control towards it.
The front panel display is blank	<ul style="list-style-type: none"> <input type="checkbox"/> The display hasn't been turned off. Press the DISPLAY button on the front panel or remote control.
No picture is being produced	<ul style="list-style-type: none"> <input type="checkbox"/> Your viewing device is turned on and switched to display your receiver. Test by pressing the MENU button on the receiver or on the remote and look for the main menu screen on your display device. <input type="checkbox"/> The correct video input is selected on the receiver. <input type="checkbox"/> The video source is on, is operating normally, and is in 'play' mode if appropriate.
There are bright edges or 'ghosts' on the picture	<ul style="list-style-type: none"> <input type="checkbox"/> Ensure the 'sharpness' control on your display device is switched off or set to near minimum. <input type="checkbox"/> For hdmi connections, try using a shorter cable or alternatively a different brand.
No sound is produced	<ul style="list-style-type: none"> <input type="checkbox"/> The correct input has been selected. <input type="checkbox"/> The 'audio source' has been set correctly in the 'input config.' Menu <input type="checkbox"/> The source equipment is on, is operating normally and is in 'play' mode if appropriate. <input type="checkbox"/> The volume is turned up to a reasonable level and the receiver is not in mute mode.
The sound is poor or distorted	<ul style="list-style-type: none"> <input type="checkbox"/> You have not excessively increased the input sensitivity (i.E. Reduced the maximum input signal voltage) in the input config. Menu if an analogue input is being used. <input type="checkbox"/> You have selected the correct size of speakers to suit your system in the setup menu.

Problem	Check the following
Sound only comes from some of the speakers	<ul style="list-style-type: none"> <input type="checkbox"/> You have an appropriate surround source selected and playing. <input type="checkbox"/> The bd/dvd disc is encoded in the appropriate format, and the correct format has been selected in the disc start menu of the bd player (if applicable). <input type="checkbox"/> The bd/dvd player has been set to output 'bitstream' audio on the digital output. <input type="checkbox"/> The display window indicates that the disc you are playing is a multichannel recording (you may need to press the INFO key several times until you get to the 'incoming format' display). <input type="checkbox"/> All the speakers are correctly connected to the speaker terminals and are secure. <input type="checkbox"/> You have not selected 'stereo' as the decoding mode. <input type="checkbox"/> Your speaker balance is correct. <input type="checkbox"/> You have configured the receiver to include all the speakers in your system.
Unable to select Dolby or DTS decoding modes	<ul style="list-style-type: none"> <input type="checkbox"/> The receiver can only apply dolby and dts decoding to sources which have been encoded in the same format. <input type="checkbox"/> Check that: <ul style="list-style-type: none"> <input type="checkbox"/> Digital source is selected and connected. <input type="checkbox"/> The source is playing appropriately encoded material. <input type="checkbox"/> The bd/dvd disc is encoded in the appropriate format and that the correct format has been selected in the disc start menu of the bd player (if applicable). <input type="checkbox"/> The bd/dvd player has been set to output 'bitstream' audio on the digital output.
When playing a Dolby BD/DVD, the AV selects Dolby Surround	<ul style="list-style-type: none"> <input type="checkbox"/> You have a digital connection from your bd/dvd player. <input type="checkbox"/> Sometimes dolby bd/dvd discs contain material at either the beginning or the end of the main movie that is not in full 5.1 Format, but in two-channel.
Hum on the analogue input	<ul style="list-style-type: none"> <input type="checkbox"/> All cables are making a good connection. If necessary withdraw the cable from the connector and plug it fully in again (turn the power off before doing this). <input type="checkbox"/> The connections inside the source cable connector are not broken or badly soldered. <input type="checkbox"/> If the hum originates only when one particular source component is connected, that an aerial cable, or dish connection to this source is ground isolated. Contact your installation contractor.

Problem	Check the following
There is radio or television reception interference	<ul style="list-style-type: none"> <input type="checkbox"/> Where the interference is coming from. Switch off each source component in turn, then any other equipment. Most electronic equipment does generate low levels of interference. <input type="checkbox"/> Try re-arranging cabling from the nuisance source away from other cabling. <input type="checkbox"/> Ensure that the cabling used is high quality, specified for its purpose, and is properly screened. <input type="checkbox"/> If the problem persists, contact your dealer.
The source switching changes randomly or freezes on one source	<ul style="list-style-type: none"> <input type="checkbox"/> There are no static or impulse interference problems caused by nearby power equipment switching, e.G., Heating or air conditioning control. Switch the receiver off, wait ten seconds, then switch it on again to clear an operating problem. Contact your installer if the problem returns or persists. <input type="checkbox"/> There is no direct sunlight shining on the infra-red detector behind the front panel display.
Volume is always too loud when I turn on	<ul style="list-style-type: none"> <input type="checkbox"/> The 'max on volume' setting is not set too high.
If files on a NAS drive cannot be played	<ul style="list-style-type: none"> <input type="checkbox"/> The files are in a compatible format. <input type="checkbox"/> The computer is connected via a network and not usb – the receiver usb port cannot be used for a direct connection to a computer
If you cannot connect to a wired network	<ul style="list-style-type: none"> <input type="checkbox"/> The ethernet cable you are using is correctly connected between the receiver and the network hardware. <input type="checkbox"/> The network is set up for fixed ip addressing and you have the receiver set to use dhcp. <input type="checkbox"/> The network is set up for dhcp and you have the receiver set to use fixed ip addressing.
If you cannot connect to a favourite internet radio station	<ul style="list-style-type: none"> <input type="checkbox"/> The station is still broadcasting or is not congested – try again later.
If the internet radio station sound quality is poor or broken	<ul style="list-style-type: none"> <input type="checkbox"/> The radio station has a low bit rate (use the INFO key to find this). <input type="checkbox"/> The network is not slow or congested.

Specifications

AV41

Stereo line inputs	
Maximum input	4.5V rms
Nominal sensitivity	1V, 2V, 4V (user adjustable)
Input impedance	47k Ω
Signal/noise ratio (A-wtd ref 100W) normal/stereo direct	93dB/110dB
Frequency response	20Hz—20kHz \pm 0.1dB
Preamplifier outputs	
Nominal output level (single-ended/balanced)	1V RMS/2V RMS
Output impedance	560 Ω
THD+N (20Hz—20kHz)	-100dB
Headphone output	
Maximum output level into 32 Ω	5Vrms
Output impedance	<100 Ω
General	
Mains voltage	110–120V or 220–240V, 50–60Hz
Power consumption (maximum)	50W (Thermal dissipation approx. 170 BTU/hour)
Power consumption (idle, typical)	40W (Thermal dissipation approx. 170 BTU/hour)
Power consumption (standby)	<0.5W
Dimensions W x D (including speaker terminals) x H (including feet)	433 x 425 x 171mm
Weight (net)	10.6kg
Weight (packed)	13.9kg
Supplied accessories	Mains lead Remote control with 2 x AAA batteries Manual DAB/FM aerial 3 x WiFi/Bluetooth antennas Calibration microphone USB cable
E&OE	
NOTE: All specification values are typical unless otherwise stated.	

Continual improvement policy: Arcam has a policy of continual improvement for its products. This means that designs and specifications are subject to change without notice.

AVR31

Continuous power output, per channel, 8 Ω /4 Ω	
2 channels driven, 20Hz - 20kHz, <0.02% THD	120W/200W
2 channels driven, 1kHz, 0.2% THD	140W/220W
7 channels driven, 1kHz, 0.2% THD	100W/180W
Residual noise & hum (A-wtd)	<0.15mV
Stereo line inputs	
Maximum input	4.5V rms
Nominal sensitivity	1V, 2V, 4V (user adjustable)
Input impedance	47k Ω
Signal/noise ratio (A-wtd ref 100W) normal/stereo direct	93dB/110dB
Frequency response	20Hz—20kHz \pm 0.1dB
Preamplifier outputs	
Nominal output level	1V RMS
Output impedance	560 Ω
THD+N (20Hz—20kHz)	-100dB
Headphone output	
Maximum output level into 32 Ω	5Vrms
Output impedance	<100 Ω
General	
Mains voltage	110–120V or 220–240V, 50–60Hz
Power consumption (maximum)	1.5kW (Thermal dissipation approx. 5200 BTU/hour)
Power consumption (idle, typical)	100W (Thermal dissipation approx. 340 BTU/hour)
Power consumption (standby)	<0.5W
Dimensions W x D (including speaker terminals) x H (including feet)	433 x 425 x 171mm
Weight (net)	18.1kg
Weight (packed)	21.4kg
Supplied accessories	Mains lead Remote control with 2 x AAA batteries Manual DAB/FM aerial 3 x WiFi/Bluetooth antennas Calibration microphone USB cable
E&OE	
NOTE: All specification values are typical unless otherwise stated.	

AVR21

Continuous power output, per channel, 8Ω/4Ω	
2 channels driven, 20Hz - 20kHz, <0.02% THD	110W/175W
2 channels driven, 1kHz, 0.2% THD	125W/190W
7 channels driven, 1kHz, 0.2% THD	90W/110W
Residual noise & hum (A-wtd)	<0.15mV
Stereo line inputs	
Maximum input	4.5V rms
Nominal sensitivity	1V, 2V, 4V (user adjustable)
Input impedance	47kΩ
Signal/noise ratio (A-wtd ref 100W) normal/stereo direct	93dB/110dB
Frequency response	20Hz—20kHz ± 0.2dB
Preamplifier outputs	
Nominal output level	1V RMS
Output impedance	560Ω
THD+N (20Hz—20kHz)	-100dB
Headphone output	
Maximum output level into 32Ω	5Vrms
Output impedance	<100Ω
General	
Mains voltage	110–120V or 220–240V, 50–60Hz
Power consumption (maximum)	1.5kW (Thermal dissipation approx. 5200 BTU/hour)
Power consumption (idle, typical)	100W (Thermal dissipation approx. 340 BTU/hour)
Power consumption (standby)	<0.5W
Dimensions W x D (including speaker terminals) x H (including feet)	433 x 425 x 171 mm
Weight (net)	16.6kg
Weight (packed)	19.9kg
Supplied accessories	Mains lead Remote control with 2 x AAA batteries Manual DAB/FM aerial 3 x WiFi/Bluetooth antennas Calibration microphone USB cable
E&OE	
NOTE: All specification values are typical unless otherwise stated.	

AVR11

Continuous power output, per channel, 8Ω/4Ω	
2 channels driven, 20Hz - 20kHz, <0.02% THD	80W/100W
2 channels driven, 1kHz, 0.2% THD	85W/120W
7 channels driven, 1kHz, 0.2% THD	60W/85W
Residual noise & hum (A-wtd)	<0.15mV
Stereo line inputs	
Maximum input	4.5V rms
Nominal sensitivity	1V, 2V, 4V (user adjustable)
Input impedance	47kΩ
Signal/noise ratio (A-wtd ref 100W) normal/stereo direct	93dB/110dB
Frequency response	20Hz—20kHz ± 0.2dB
Preamplifier outputs	
Nominal output level	0.8V RMS
Output impedance	560Ω
THD+N (20Hz—20kHz)	-100dB
Headphone output	
Maximum output level into 32Ω	5Vrms
Output impedance	<100Ω
General	
Mains voltage	110–120V or 220–240V, 50–60Hz
Power consumption (maximum)	1.5kW (Thermal dissipation approx. 5200 BTU/hour)
Power consumption (idle, typical)	90W (Thermal dissipation approx. 340 BTU/hour)
Power consumption (standby)	<0.5W
Dimensions W x D (including speaker terminals) x H (including feet)	433 x 425 x 171 mm
Weight (net)	16.5kg
Weight (packed)	19.8kg
Supplied accessories	Mains lead Remote control with 2 x AAA batteries Manual DAB/FM aerial 3 x WiFi/Bluetooth antennas Calibration microphone USB cable
E&OE	
NOTE: All specification values are typical unless otherwise stated.	

Worldwide Guarantee

This entitles you to have the unit repaired free of charge, during the first five years after purchase, provided that it was originally purchased from an authorised Arcam dealer. The Arcam dealer is responsible for all after-sales service. The manufacturer can take no responsibility for defects arising from accident, misuse, abuse, wear and tear, neglect or through unauthorised adjustment and/or repair, neither can they accept responsibility for damage or loss occurring during transit to or from the person claiming under the guarantee.

The warranty covers:

Parts (excluding disc drives) and labour costs for five years from the purchase date (see below for additional terms and conditions). After five years you must pay for both parts and labour costs.

*Disc drives (of any type) are covered under this warranty for **three** years from the purchase date.*

The warranty does not cover battery replacement at any time.

The warranty does not cover transportation costs at any time.

Claims under guarantee

This equipment should be packed in the original packing and returned to the dealer from whom it was purchased. It should be sent carriage prepaid by a reputable carrier – **not by post**. No responsibility can be accepted for the unit whilst in transit to the dealer or distributor and customers are therefore advised to insure the unit against loss or damage whilst in transit.

For further details contact Arcam at luxurysupport@harman.com.

Problems?

If your Arcam dealer is unable to answer any query regarding this or any other Arcam product please contact Arcam Customer Support at the above address and we will do our best to help you.

On-line registration

You can register your product on-line at www.arcam.co.uk.