

INSTALLATION MANUAL

VISUAL PERFORMANCE® ROUND SPEAKERS AND SQUARE ADAPTERS



Introduction

Thank you for purchasing Sonance Visual Performance® Round Speakers. When properly installed your new speakers will give you years of entertainment pleasure.

Box Contents

Visual Performance in-ceiling speaker box contains (2) Visual Performance speakers, (2) paintable grilles and (2) mounting cut-out templates.

NOTE: SST/SUR speaker box content will contain (1) Visual Performance speaker, (1) paintable grille and (1) mounting cut-out template.

Speaker Placement

Stereo Speaker Placement (2-Channel System)

- Place the left and right speakers anywhere from 6 - 10 feet (1.8m - 3m) apart, with the main listening position as close to midway between the speakers as possible.
- In most cases pivoting the woofer and/or midrange/tweeter assembly of each speaker directly towards the main listening position will help maximize the stereo soundstage.

Use the Left and Right speaker placement in Figures 2 and 3, on the left side of image, as a guide.

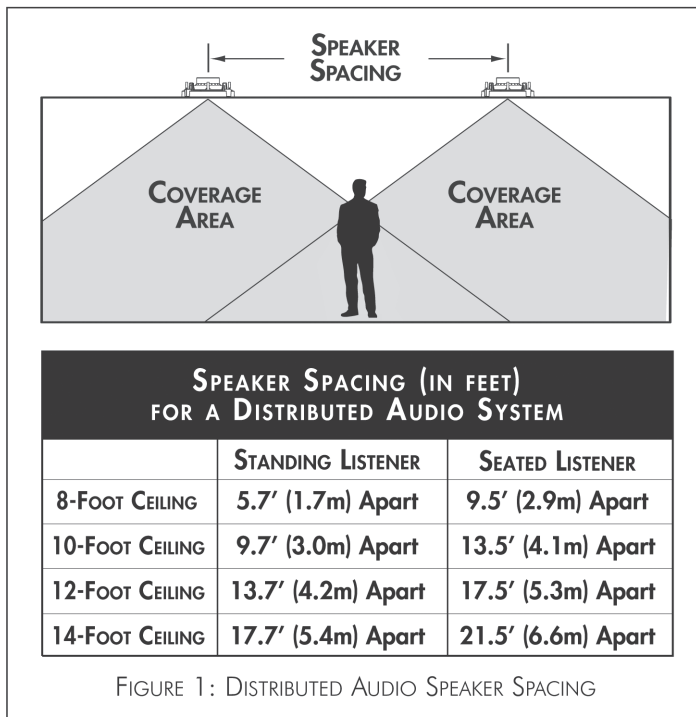

FIGURE 1: DISTRIBUTED AUDIO SPEAKER SPACING

Home Theater Speaker Placement

Left, Center & Right Speakers (see Figure 2)

- Place the left, center and right speakers 1 - 2 feet (0.3m - 0.6m) in front of the video screen, 6 - 10 feet (1.8m - 3m) apart, with the center channel speaker as close to midway between the left and right speakers as possible.
- The main listening position should be 4 - 10 feet (1.2m - 2m) away from the speakers.

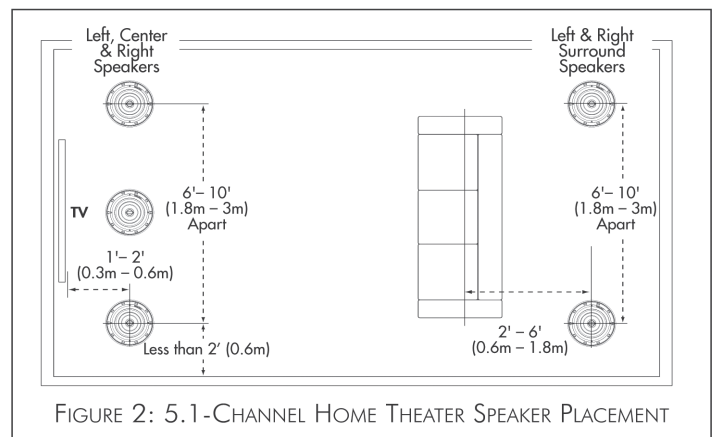

FIGURE 2: 5.1-CHANNEL HOME THEATER SPEAKER PLACEMENT

Surround Speakers — 5.1-Channel System (see Figure 2)

- Locate the left and right surround speakers 2 - 6 feet (0.6m - 1.8m) behind the listening position. The speakers should be 6 - 10 feet (1.8m - 3m) apart.

Surround Speakers — 7.1-Channel System (see Figure 3)

- Left & Right Surround Speakers:** Place the left and right surround speakers directly to the sides of the listening position, 6 - 10 feet (1.8m - 3m) apart.
- Surround Back Speakers:** Place the surround back speakers 2 - 6 feet (0.6m - 1.8m) behind the listening position. The surround back speakers should be closer together than the left and right surround speakers, 3 - 6 feet (0.9m - 1.8m) apart.

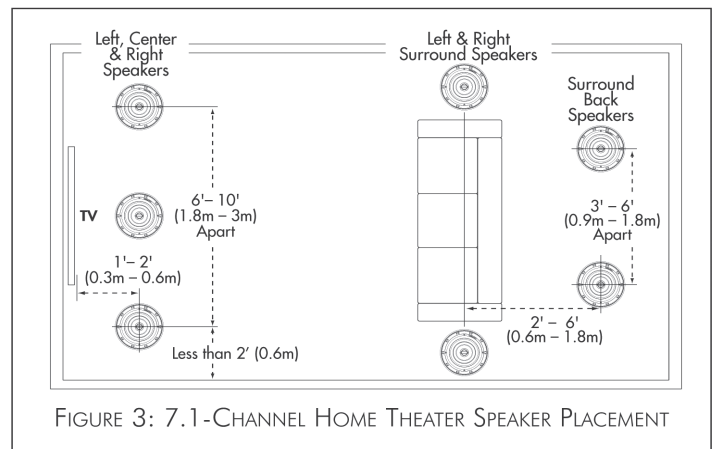

FIGURE 3: 7.1-CHANNEL HOME THEATER SPEAKER PLACEMENT

VISUAL PERFORMANCE® ROUND SPEAKERS

Before Installation

1. Determine the location for the speaker (see Speaker Placement on page 1).
2. Perform an obstruction survey using a stud finder to be certain that there are no studs, conduit, pipes, heating, ducts, pocket doors or air returns in the ceiling cavity that will interfere with the speaker. If you are unsure about obstructions, drill a small hole in the center of the outline and insert a coat hanger wire into the hole to feel around for possible obstructions.
3. Cut the mounting hole using a keyhole or drywall saw, and run the speaker wires from the mounting hole to the amplifier location.

NOTE: CONSULT LOCAL BUILDING CODES BEFORE RUNNING SPEAKER WIRES THROUGH CEILINGS.

Installation

Sonance Visual Performance Speakers feature integral Roto-Lock® mounting system for quick mounting directly into existing ceilings.

1. Strip 1/4" – 1/2" (6mm – 12mm) of insulation from each speaker lead. Twist the strands or tin the exposed wire with solder to ensure that there are no stray strands.

NOTE: STRAY STRANDS THAT TOUCH EACH OTHER CAN CAUSE A SHORT-CIRCUIT THAT CAN DAMAGE THE AMPLIFIER.

2. The speaker's terminals are spring-loaded. Push the top of each terminal down to open the connector and insert the exposed wires into the holes in the spring terminals.

The speaker's positive spring terminal is labeled with a red dot; the negative spring terminal is labeled with a black dot. Double-check that you connected amplifier "+" to speaker "+" and amplifier "-" to speaker "-".

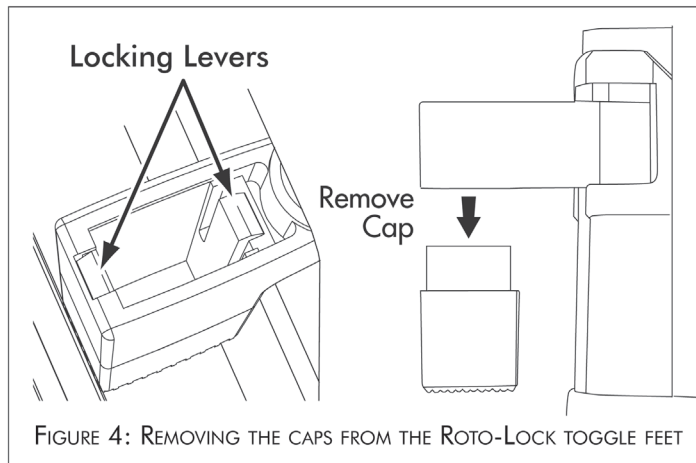

3. Make sure all the Roto-Lock toggle feet are retracted so that they are tucked within the mounting hole's border. Insert the speaker into the hole in the ceiling (Figure 5). The Roto-Lock system can accommodate a ceiling material thickness of 1-1/4" (32mm) with the toggle foot cap removed the system can accommodate a ceiling material thickness of 1-7/8" (48mm).

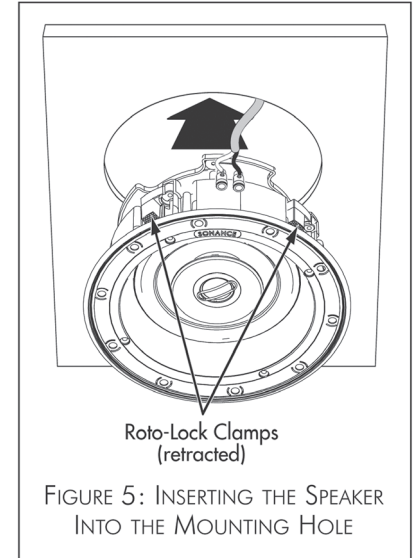

4. When installing into double drywall or other thicker ceiling materials, you may need to remove part of the two-piece toggle feet. Use a small screwdriver to gently release the two locking levers (Figure 4).

5. Tighten the screws on the front of the speaker baffle. The Roto-Lock toggle feet will automatically rotate into position and begin clamping the speaker (Figure 6). When you notice resistance on the screws the speaker has been clamped successfully.

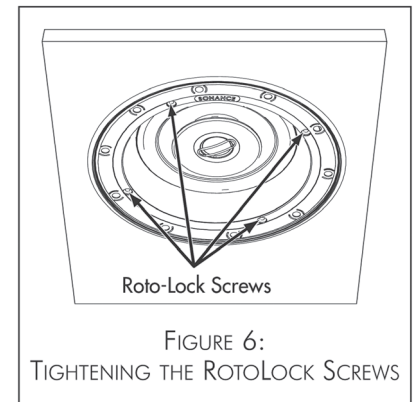

IMPORTANT: ALWAYS USE LOW TORQUE SETTINGS; NEVER OVER-TIGHTEN.

NOTE: ADJUST THE TENSION OF THE ROTO-LOCK CLAMPS SO THAT THE SPEAKER FRAME IS FLAT. THIS WILL HELP ENSURE THAT THE GRILLE CONTACTS THE CEILING ALL THE WAY AROUND THE SPEAKER FOR A PROPER FIT.

6. The micro-trim grille is held in place by several small, powerful magnets on the speaker frame. Place the grille against the speaker and the magnets will hold it firmly in place. When properly installed, the grille trim should make contact with the wall all the way around the speaker.

VISUAL PERFORMANCE® ROUND SPEAKERS

Speaker Adjustments

Pivoting Woofer and Midrange/Tweeter

Some Visual Performance Round Speakers have a pivoting woofer and a pivoting midrange/tweeter assembly. If you're using the speakers in stereo or as the front left/center/right speakers in a home theater, pivot the drivers directly towards the listening area. If you're using the speakers as surround channel speakers in a home theater, pivot the drivers towards a wall or window, away from the listeners.

To pivot the drivers apply light pressure to the ring around the outside edge of the woofer, midrange and tweeter cone, as shown in Figure 7. Take care not to touch or apply pressure to the cone itself.

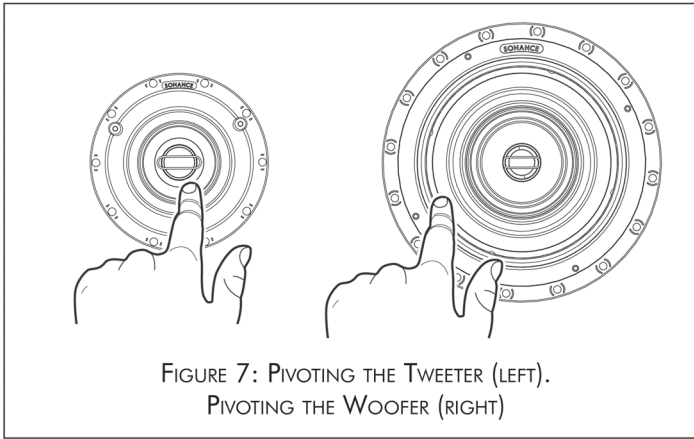

FIGURE 7: PIVOTING THE TWEETER (LEFT).
PIVOTING THE WOOFER (RIGHT)

VP68R & VP88R - Tweeter Level Switch

The VP68R and VP88R speakers have a tweeter level switch (see Figure 8). To increase the output from the tweeter slide the switch towards the + mark under the switch. To decrease the output from the tweeter slide the switch towards the - mark under the switch.

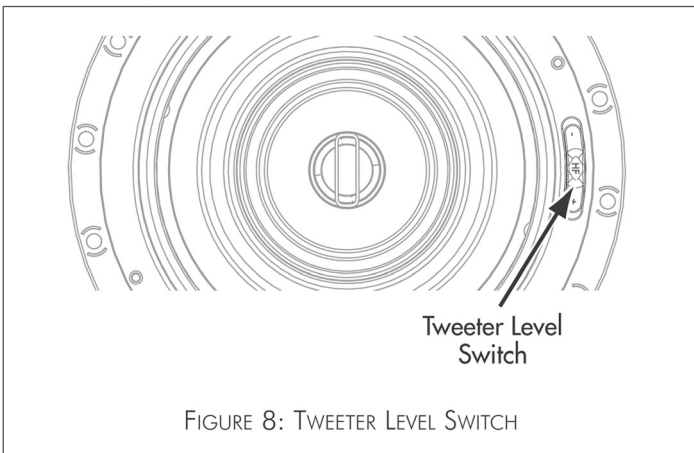

FIGURE 8: TWEETER LEVEL SWITCH

Square Adapter Instructions

The VPSQ Square Adapter with Grille slide on through the rear of the round speaker prior to installation (Figure 9). Place speaker through the round ceiling cut-out, loosely tighten the Roto-Lock toggle feet (Figure 10), then align the Square Adapter on the speaker to the correct symmetry (Figure 11).

Once the Square Adapter is straight in line with other speakers, lighting, and/or HVAC ceiling fixtures, secure the Roto-Lock toggle feet at a low torque setting and attach the magnetic grille. The Square Adapter includes small screw holes that can be used to tighten the adapter to keep the corners flush to the ceiling in case of heavy textures.

Note: #6 drywall screws and drywall anchors not included. Screws will not always be necessary for every installation.

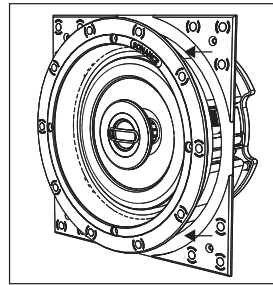

FIGURE 9

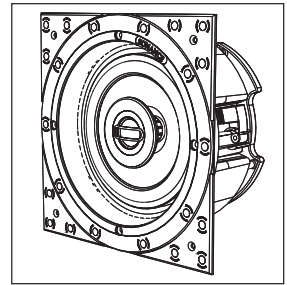

FIGURE 10

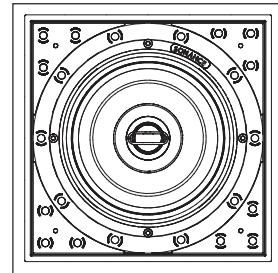

FIGURE 11

Box Contents

(2) VP square adapters and (2) grilles.

Order Numbers

1 PAIR	SKU
VP4SQ Square Adapter w/Grille	93029
VP6SQ Square Adapter w/Grille	93030
VP8SQ Square Adapter w/Grille	93031
5 PAIR BULK PACK	SKU
VP4SQ Square Adapter w/Grille	93032
VP6SQ Square Adapter w/Grille	93033
VP8SQ Square Adapter w/Grille	93034

VISUAL PERFORMANCE® ROUND SPEAKERS

SST / SUR Setup and Connection

Use as a Surround (SUR)

Connect the + and - wires from your amplifier or receiver to either pair of terminals on the VP SST/SUR speaker. Remove the red sticker and set the switch to SUR.

Use as a Single Stereo Technology (SST)

Connect the + and - wires from the left channel to one pair of terminals and the + and - wires from the right channel to the other pair of terminals .

The switch is preset in the SST mode and should not be changed (figure 12).

NOTE: WHEN THE SWITCH IS PLACED IN THE SUR MODE THE TWO PAIRS OF BINDING POSTS ARE CONNECTED! DAMAGE CAN OCCUR TO YOUR AMPLIFIER IF YOU CONNECT TWO DIFFERENT AMPLIFIER CHANNELS TO THE SPEAKER WITH THE SWITCH SET IN SUR MODE.

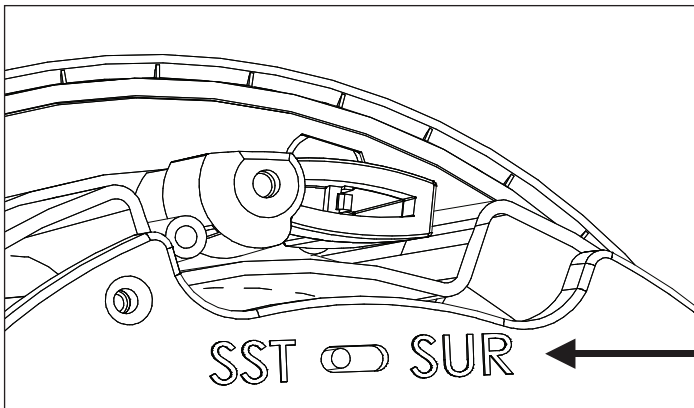
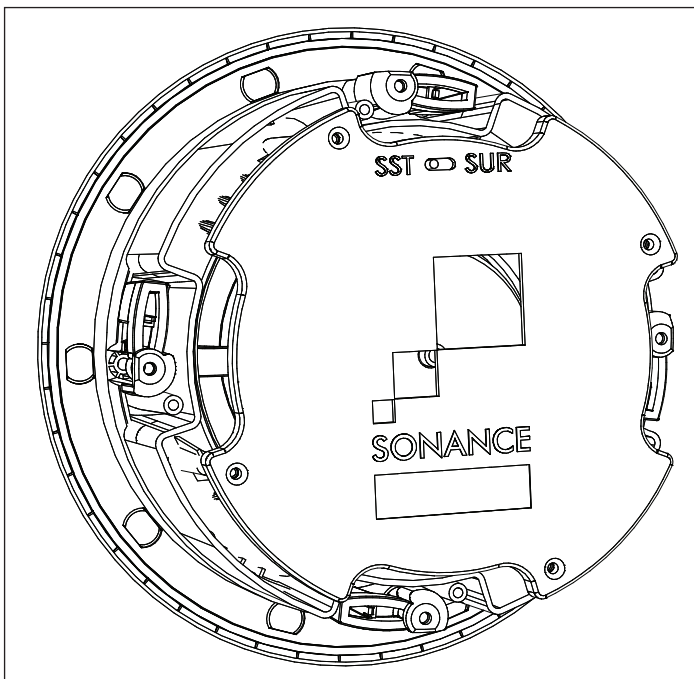

FIGURE 12



LIMITED LIFETIME WARRANTY

Sonance warrants to the first end-user purchaser that this Sonance-brand product ("Product"), when purchased from an authorized Sonance Dealer/Distributor, will be free from defective workmanship and materials for the life of the Product, except for the grille, which is warranted for five (5) years. Sonance will at its option and expense either repair the defect or replace the Product with a new or remanufactured Product or a reasonable equivalent.

EXCLUSIONS

TO THE EXTENT PERMITTED BY LAW, THE WARRANTY SET FORTH ABOVE IS IN LIEU OF, AND EXCLUSIVE OF, ALL OTHER WARRANTIES, EXPRESS OR IMPLIED, AND IS THE SOLE AND EXCLUSIVE WARRANTY PROVIDED BY SONANCE. ALL OTHER EXPRESS AND IMPLIED WARRANTIES, INCLUDING THE IMPLIED WARRANTIES OF MERCHANTABILITY, IMPLIED WARRANTY OF FITNESS FOR USE, AND IMPLIED WARRANTY OF FITNESS FOR A PARTICULAR PURPOSE ARE SPECIFICALLY EXCLUDED. No one is authorized to make or modify any warranties on behalf of Sonance.

The warranty stated above is the sole and exclusive remedy and Sonance's performance shall constitute full and final satisfaction of all obligations, liabilities and claims with respect to the Product. IN ANY EVENT, SONANCE SHALL NOT BE LIABLE FOR CONSEQUENTIAL, INCIDENTAL, ECONOMIC, PROPERTY, BODILY INJURY, OR PERSONAL INJURY DAMAGES ARISING FROM THE PRODUCT, ANY BREACH OF THIS WARRANTY OR OTHERWISE.

This warranty statement gives you specific legal rights, and you may have other rights which vary from state to state. Some states do not allow the exclusion of implied warranties or limitations of remedies, so the above exclusions and limitations may not apply. If your state does not allow disclaimer of implied warranties, the duration of such implied warranties is limited to period of Sonance's express warranty.

Your Product Model and Description: Sonance Visual Performance Round Speakers & Square Adapters

Additional Limitations and Exclusions from Warranty Coverage: The warranty described above is non-transferable, applies only to the initial installation of the Product, does not include installation of any repaired or replaced Product, does not include damage to allied or associated equipment which may result for any reason from use with this Product, and does not include labor or parts caused by accident, disaster, negligence, improper installation, misuse (e.g. overdriving the amplifier or speaker, excessive heat or cold or humidity, outdoor installation), or from service or repair which has not been authorized by Sonance.

Obtaining Authorized Service: To qualify for the warranty, you must contact your authorized Sonance Dealer/Installer or call Sonance Customer Service at (949) 492-7777, must obtain a return merchandise number (RMA), and must deliver the Product to Sonance shipping prepaid during the warranty period, together with the original sales receipt, or invoice or other satisfactory proof of purchase.



©2013 Sonance. All rights reserved.

Sonance, Visual Performance and Roto-Lock are registered trademarks of Dana Innovations.

Due to continuous product improvement, all features and specifications are subject to change without notice.

For the latest Sonance product specification information visit our website: www.sonance.com

SONANCE • 991 Calle Amanecer • San Clemente, CA 92673 USA
(949) 492-7777 • FAX: (949) 361-5151 • Technical Support: (949) 492-7777

www.sonance.com