

SL EVOLVE 6-3

The SL Evolve Series is Artcoustic's most versatile range of products. Its slimline profile, combined with a powerful and articulated performance, makes it the ideal choice for high-end cinema, Hi-Fi and, multi-room audio installations.

Operating Range: 65 Hz (-3 dB) to 40 kHz
 Sensitivity: 98 dB
 Maximum Power Handling: 180 Watt
 Impedance: 5 ohms nominal
 Average Peak SPL: 120 dB
 Weight: 5.2 kg
 Dimensions: H: 370 W: 270 D: 72 mm
 Cabinet: Black, White, RAL, NCS
 Screen: Black, White, RAL, NCS, Artcoustic Art Gallery



SCHEMATICS

dimensions are in mm

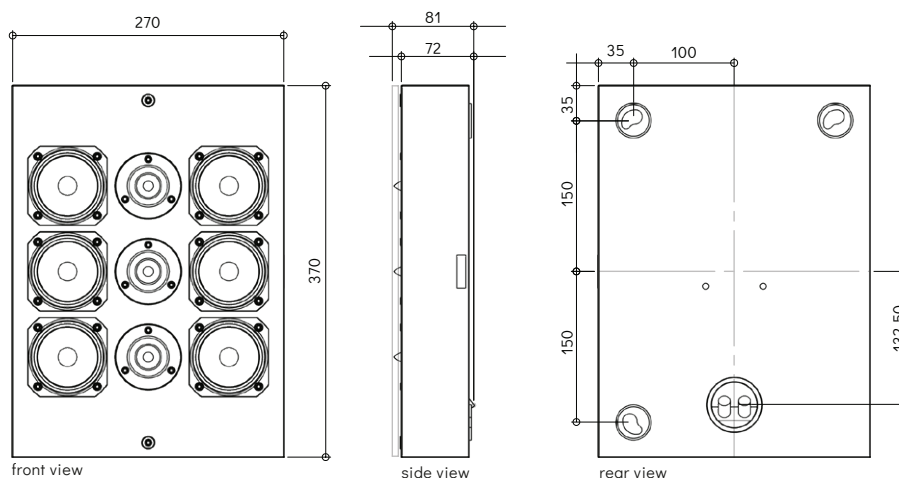

POLAR RESPONSE

horizontal polar response 2m

16000Hz - - - - -
 6500Hz - - - - -
 2500Hz - - - - -
 1000Hz - - - - -

vertical polar response 2m

3D polar response 2m

